



TC 系列 永磁变频螺杆空压机

TC series permanent magnet frequency conversion screw air compressor

使 用 手 册

苏州晨恩斯可络压缩机有限公司

Suzhou Chanun Screw Compressor Co.,Ltd.

致 谢

感谢您选用苏州晨恩精灵系列永磁变频螺杆空气压缩机；此说明书将帮助您更好的使用我们为您提供的强大的空气动力压缩系统。我们欢迎您随时给我们提出宝贵的建议或意见。

如果您在使用我们机器的过程中遇到了任何问题，您可以通过以下几种方式和我们的客户服务技术中心及时的取得联系，我们会尽快的解决您的问题。

- 1、24 小时客户服务热线： 400-691-9399
- 2、欢迎您登陆我们的网站：www.chanun.com.cn 获得及时的在线服务。
- 3、发送邮件至 sales@chanun.com.cn

我们尽量保证手册的完整性和准确性，但苏州晨恩将保留对产品不断研发和改进的权利而不负有对以前出厂的产品进行修改和改进的义务，当产品设计变更时将不再另行通知。

Thanks

Thank you for choosing Suzhou Chanun Genie series permanent magnet variable frequency screw air compressor; this manual will help you better use the powerful aerodynamic compression system we provide you. We welcome you to give us valuable suggestions or comments at any time.

If you encounter any problems in the process of using our machine, you can get in touch with our customer service technical center in the following ways, and we will solve your problem as soon as possible.

1. 24-hour customer service hotline: 400-691-9399
2. Welcome to visit our website: www.chanun.com.cn to get timely online services.
3. Send an email to sales@chanun.com.cn

We try our best to ensure the completeness and accuracy of the manual, but Suzhou Chanun will reserve the right to continuously develop and improve the products and will not be obligated to modify and improve the previous products. When the product design changes, there will be no further notify.

前 言

本操作手册详细叙述了苏州晨恩设计生产的精灵系列螺杆空气压缩机的安全注意事项，各系统和组件的结构功能以及操作维护方法。

操作人员应仔细阅读完本操作手册，在充分了解机组各系统和组件的结构功能和安全注意事项之后，方能对机组进行操作和维护。除本书中有说明的外，如用户不按本书的操作维护规程进行操作和维护保养，或自行对机器进行解体 and 改装，或使用了非苏州晨恩指定的油品和零件，您将会失去索赔的权利。

本操作手册未向您提供零部件图解目录。如果您需要向本公司订购零件，请查阅相关机组零件手册。需要提醒您注意的是，苏州晨恩对产品不断进行研发和改进，一定时期以后，零件手册的内容与产品的实际情况可能会有所出入。在您订购零件之前，请先与本公司服务部核实。

本操作手册对电机及电气系统和维护作了一般性的介绍，但您在使用和维护本机组之前，如还有疑问，请与当地经销商或晨恩服务部联系。

——编者

二〇二四年六月

Foreword

This operation manual describes in detail the safety precautions of the wizard series screw air compressor designed and produced by Suzhou Chanun, the structure and function of each system and component, and the operation and maintenance methods.

The operator should read this operation manual carefully, and only after fully understanding the structure, function and safety precautions of each system and component of the unit, can the unit be operated and maintained. Except as stated in this book, if the user does not operate and maintain according to the operation and maintenance procedures of this book, or disassemble and modify the machine by himself, or use oil and parts not specified by Suzhou Chanun, you will Will lose the right to claim.

This operating manual does not provide you with an illustrated catalog of parts. If you need to order parts from our company, please refer to the relevant unit parts manual. What needs to be reminded is that Suzhou Chanun continues to develop and improve its products. After a certain period of time, the content of the parts manual may differ from the actual situation of the product. Before you order parts, please check with our company's service department.

This operation manual gives a general introduction to the motor and electrical system and maintenance, but before you use and maintain this unit, if you have any questions, please contact your local dealer or Chanun service department.

--Editor
June 2024

标准担保条款

苏州晨恩对其自己制造的螺杆式空气压缩机产品在正常使用、维护、维修和保养情况下，就其制造工艺及材料缺陷方面实行如下担保。

精灵系列螺杆压缩机整机：装运出厂日起 13 个月或试车起 12 个月，以先到为准。

压缩机机头：依照机头保固协议。

返修的压缩机机头：从装运出厂日起 6 个月。

备品备件（三滤，油除外）：从装运出厂日起 6 个月或试车起 3 个月，以先到为准。

对于非苏州晨恩制造的产品，在可行的条件下，将直接引用原制造商的担保条款。在担保期内，必须在发现瑕疵 30 天以内以书面通知苏州晨恩或授权代理商，并附所有供辨认鉴定之详细资料，包括出厂序号，机型，购买日期等。

苏州晨恩在此担保条款下的单一责任为，依据判断对任何被证明为瑕疵品的产品或零件加以修复，更换。在必要的情况下，苏州晨恩可要求用户将瑕疵产品或零件以预付运费方式送回厂家进行检查工作。

苏州晨恩对修理之产品，零件或更换之零件（由其自己制造者）在正常使用、维护、维修和保养情况下，担保期为 3 个月或该修理产品的剩余担保期。

对下列责任，本担保条款不适用，而且苏州晨恩亦无责任或义务：

- A. 间接造成的，附带的或特殊的损失或损坏。
- B. 正常磨损，非正常使用条件，疏忽或不当使用设备，不当储存或运输造成的损坏。
- C. 不遵守操作指令的规定，规范或其他特殊的销售条件。
- D. 劳工费用，不当操作（运转）维护和非卖方或卖方授权之维修人员所做维修所致损失或损害。
- E. 产品的不合理使用。

在任何情况下卖方的赔偿义务仅限于不超过售价的范围。无论索赔是因合同的废止，还是由生产疏忽的担保所产生。

NOTICE!

本担保条款为卖方的单一担保条款，任何其他的担保条款，无论是在法律上明确陈述或暗喻的，或事实暗喻的，包括任何商品性以及使用于某特殊用途等方面的担保条款均予以排除，不予接受。

三滤、油保养周期特别提示

序号	项目	时 间	保养内容	备 注
1	首保	新机运行 500 小时	更换润滑油 更换油过滤器 更换空滤芯 更换油细分离器	
2	常规保养	运行 3000 小时	更换润滑油 更换油过滤器 更换空滤芯 更换油细分离器	

★注：恶劣工况下保养周期适当缩短。

Standard guarantee clause

Suzhou Chanun implements the following guarantees for its manufacturing process and material defects under normal use, maintenance, repair and maintenance of its own screw air compressor products.

Wizard series screw compressor: 13 months from the date of shipment or 12 months from the trial run, whichever comes first.

Compressor head: in accordance with the head warranty agreement.

Compressor head returned for repair: 6 months from the date of shipment.

Spare parts (except for three filters, oil): 6 months from the date of shipment from the factory or 3 months from the trial run, whichever comes first.

For products not manufactured by Suzhou Chanun, where feasible, the original manufacturer's warranty terms will be directly quoted. During the warranty period, you must notify Suzhou Chanun or its authorized agent in writing within 30 days after the defect is discovered, and attach all detailed information for identification, including factory serial number, model, date of purchase, etc.

Suzhou Chanun's single responsibility under this warranty clause is to repair and replace any product or part that is proved to be defective based on its judgment. If necessary, Suzhou Chanun may request users to send defective products or parts back to the manufacturer for inspection by way of pre-paid freight.

For repaired products, parts or replacement parts (manufactured by itself), Suzhou Chanun guarantees a period of 3 months or the remaining warranty period of the repaired product under normal use, maintenance, repair and maintenance.

For the following responsibilities, this guarantee clause does not apply, and Suzhou Chanun has no responsibilities or obligations

A. Indirect, incidental or special loss or damage.

B. Damage caused by normal wear and tear, abnormal use conditions, negligent or improper use of equipment, improper storage or transportation.

C. Failure to comply with operating instructions, specifications or other special sales conditions.

D. Labor costs, loss or damage caused by improper operation (operation) maintenance, and repairs by

non-seller or maintenance personnel authorized by the seller.

E.Unreasonable use of the product.

In any case, the seller’s liability for compensation is limited to not exceeding the selling price. Regardless of whether the claim is due to the abolition of the contract or the guarantee of negligence in production.

 **NOTICE!**

This guarantee clause is the seller’s single guarantee clause. Any other guarantee clauses, whether expressly stated or metaphorically stated in law, or metaphorical in fact, including any guarantee clauses for commodity properties and use for a special purpose, are excluded. , Not accepted.

Special reminder for three filter and oil maintenance cycle

Serial number	Project	Time	Maintenance content	Remark
1	Firstguarantee	The new machine runs for 500 hours	Change the lubricating oil Replace the oil filter Replace the air filter Replace the oil fine separator	
2	Routinemaintenance	Run for 3000 hours	Change the lubricating oil Replace the oil filter Replace the air filter Replace the oil fine separator	

★Note: The maintenance period should be shortened appropriately under severe working conditions.

目 录

第一章 安全规则	10
第二章 系统功能介绍	12
2.1 简介	12
2.2 压缩机机头及压缩循环	12
2.3 电气控制	14
2.4 控制器及功能参数表	15
第三章 安装验收	19
3.1 安装验收及保管:	19
3.2 安装定位	19
3.3 整机存放和保养	20
3.4 安装、配管及电气配线	20
3.5 配管、基础及冷却系统注意事项	20
3.6 安全设施安装	21
3.7 电气安装	22
3.8 接线示意图:	23
第四章 操作规程	24
4.1 概述	24
4.2 准备启动	24
4.3 常规启动步骤	24
4.4 停机程序	24
第五章 维护保养	25
5.1 维修保养前的准备	25
5.2 螺杆压缩机的维护保养	25
5.3 保养提示及保养后更新设置方法:	26
5.6 常见故障排除表(手动检查时需断电、断气)	28
5.7 螺杆配件爆炸示意图	29
Chapter 1 Safety Rules	31
Chapter 2 System Function Introduction	33
2.1 Introduction	33
2.2 Compressor head and compression cycle	33
2.3 Electrical control	36
2.4 Controller and function parameter table	36
1)When power is on, HMI display automatically switches to the following page.	36
Chapter 3 Installation and Acceptance	42
3.1 Installation, acceptance and storage:	42
3.2 Installation and positioning	42
For the design, installation and use of the compressor room, please refer to GBJ29-90 "Code for Design of Compressed Air Station".	43
3.3 Storage and maintenance of the whole machine	43
3.4 Installation, piping and electrical wiring	43
3.5 Precautions for piping, foundation and cooling system	43
3.6 Installation of safety facilities	45
3.7 Electrical installation	46

3.8 Wiring diagram (open the inverter cover):	47
Chapter 4 Operating Rules	48
4.1 Overview	48
4.2 Ready to start	48
4.3 Routine start-up steps	48
4.4 Shutdown procedure	48
Chapter 5 Maintenance	50
5.1 Preparation before maintenance	50
5.2 Maintenance of screw compressor	50
5.3 Maintenance tips and update setting method after maintenance:	51
5.5 Maintenance plan	52
5.7 Schematic diagram of screw fitting explosion	55

第一章 安全规则

安全警示标志

本手册中，对涉及安全的操作和事项进行了危险界定，并根据操作可能对机器造成破坏的严重性和对人身伤害的程度加以分级，分别以下述标志并用黑体字进行表述和说明。

 接地	“警告”表示开机前必须确认已正确接地。
	“注意”表示可能会造成机器一般性破坏或人员伤害的不安全因素。
	“警告”表示可能会造成财产损失或人身伤亡的不安全因素。
	“警告”表示电器设备，仅限有资格的工作人员按规范操作。
	“警告”表示机组会自动重新启动，可能对人体、设备造成严重伤害。
	“警告”表示不要触摸发热的物体表面，为防止烫伤，请不要靠近此表面。
	“警告”表示运动部件会对身体造成严重伤害，没有防护罩或防护罩损坏时不要对设备进行操作。
	“危险”表示会造成重大事故或人身伤亡的不安全因素。
	“危险”表示超过安全等级的电压会造成严重的人身伤亡的不安全因素。所有的电气作业必须由具有资格的电工担任。
	“危险”表示用于呼吸和食品处理，则压缩空气必须符合标准 OSHA 29CFR1910.134 和 FDA 21CFR178.3570 否则会造成人体伤害，甚至死亡。
	“危险”表示压力气体会对人体、设备财产造成严重损坏，甚至死亡。
	“注意”表示热的表面可能会造成财产损失或人员伤害的不安全因素。
	“注意”表示重要的安装、操作和维修信息。

安全提示

操作和使用压缩机之前务必仔细阅读



警告

压缩空气及压缩空气系统具有危险性！

不遵守本操作手册的操作程序和安全注意事项，会有酿成事故和造成您自己或其他人员伤亡的可能性！

操作和维护压缩机之前，必须仔细阅读和弄懂本操作手册！

机器出厂前，已在存在危险的地方和需要注意操作的地方贴有明显的警示贴花。

在对机组进行任何操作和维护之前，**必须**阅读和弄懂本操作手册。

1. 机组**绝不能**在高于机组额定的排气压力下运行，否则会造成电机因过载而损坏。
2. 机组在出厂时，各种保护控制均设置完好，**绝不能**随意改动或拆除机组的控制部件，否则会造成重大的设备和人身伤害事故
3. 在机组运转时，**绝不要**拆卸或松动任何管路元件、接头、堵头和联接件，不要扳动安全阀。机组内充满具有压力的热工质，能引起严重的人身伤害事故。
4. 在对机组进行任何维修工作之前，**必须**确认：
 - 机组已停车；
 - 机组内部压力已完全放空；
 - 电源已关闭。
5. **只能**使用安全溶液来清洗压缩机和机组附属设备。
6. 任何零件一旦失效，**必须**立即更换，否则有可能造成不可估量的损失。
7. 本机为室内使用设备，不可露天使用。必须接地★★★

以下所列安全措施和安全注意事项仅为使用压缩机和压缩空气系统必须遵守事项的一部分，并非全部。



警告

如果不遵守下列安全措施将会产生人员伤亡，财产损失或压缩机损坏。

只有经过培训并被授权的人才能操作压缩机。任何作业之前应仔细阅读本操作手册并充分理解其中的内容。不遵循操作手册中的操作维护规程和安全规则会有发生事故和人员伤亡的可能性。

绝不可在不安全状况下起动机组；若机组已出现问题，不要试图开机，应切断电源，作出明显标志，使不知情的人不至于误操作。

压缩空气具有危险性，只有在整个压缩机系统里的压缩空气都已放空的情况下方能对机组进行维修和保养。

不要改动机组的内部结构及控制方式，除非有苏州晨恩斯可络公司的书面认可。

如果是附带移动轮子的机组，开机前请确认轮子已采取有效措施固定。

作好日常保养和维护，每天都应仔细检查机组，查看是否有泄漏及零件的松动、损坏、调节失灵或零部件丢失等情况，发现问题及时处理。

第二章 系统功能介绍

2.1 简介

苏州晨恩设计制造的精灵系列永磁变频压缩机组是一种容积式的、喷油双螺杆压缩机，电机与压缩机机头的阳转子一体式进而驱动压缩机旋转。机组具有良好的动力性、经济性和可靠性。

本机组布局合理，功能齐全，操作维护简单，外形美观大方。所有的仪表、指示器和控制装置均集中在控制面板上，操作方便，可长期稳定可靠地运行，参见图 2-1。为使您购买或使用的螺杆压缩机组保持最佳的运行状态，请仔细阅读本操作手册的第五章 维修保养。



图 2-1

2.2 压缩机机头及压缩循环

压缩机机头（主机）。参见图 2-2，工作时，空气经过位于动力输入端的进气口进入机壳内，当转子转过机壳上的吸气孔口边缘时，一部分吸入的空气被封闭在阴、阳转子和机壳构成的螺槽封闭容积中，螺槽封闭容积随着阴阳转子的啮合运动而不断变化，从而实现连续的吸气、封闭、压缩、排气的工作循环，被压缩的空气经排气口排出进入油气桶中。

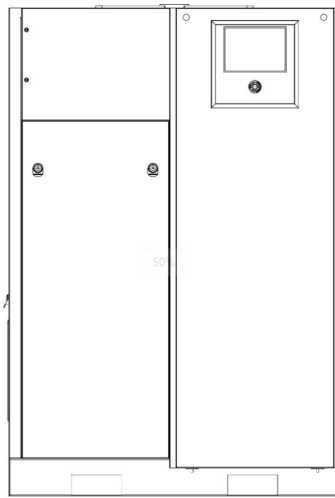
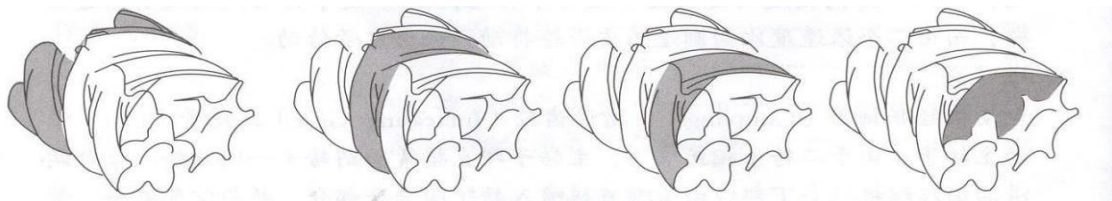

1. 吸气过程 2. 封闭及输送 3. 压缩及喷油行程 4. 排气过程

图 2-2 压缩循环

2.2.1 进气系统

参见图 2-3，压缩机机组进气系统的作用是向压缩机提供清洁干净的空气，它包括一个空气过滤器、一个进气阀。



图 2-3 进气系统

2.2.2 压缩机排气系统

压缩机组的排气系统主要由**油气桶、储气罐、组合阀、油分、安全阀**等组成

油气桶部分能够实现油和气的混合物相分离，油气桶上方安装一个油细分离器，经过油气分离后的压缩空气中仅含有几个 PPM（通常是 3PPM 以下）的润滑油。罐体左侧是储气罐部分，起缓冲作用，对空压机有很好的保护作用，可将部分的凝结水滤除，同时亦有降低气体排气温度之功能，可减轻干燥器的负荷。

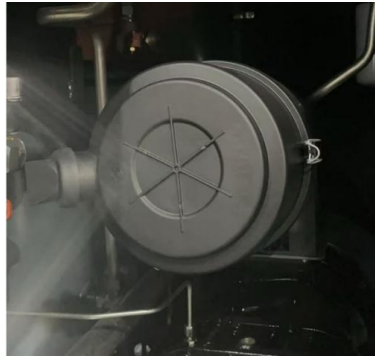
储气罐位于机器的下方存储气体。

组合阀集油细分离器座、油过滤器座、压力维持阀、安全阀接口于一体。压力维持阀作用是保证压缩机在正常运行时在系统内建立一个最小罐压，以保证润滑油路的正常工作。在机组停机时，压力维持阀又是止回阀，防止压缩空气回流。压力维持阀的开启压力为 $4.0 \pm 0.34\text{bar}$ ($60 \pm 5\text{psi}$)，出厂之前已经预设好。



图 2-5 安全阀

在桶体上装油气桶、储气罐部分各有一个**安全阀**，当罐内的气体压力超过安全阀的设定压力时，安全阀会自动打开。安全阀的开启压力在出厂前已设定好，请用户不要擅自改变。

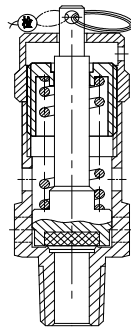

- 在压缩机运行或带压时，不要拆卸螺母、注油塞及其它零件。维护操作之前应停机并释放所有内部压力。
- 不准更换和使用其它型号的安全阀。

2.2.3 压缩机冷却与润滑系统

压缩机冷却与润滑系统由**油气桶储气罐、油冷却器、组合阀、油过滤器和油管路**等组成
油过滤器由滤座和可更换的旋装式滤芯组成，内置旁通阀，当滤芯脏堵或油的粘度过大时，确保油路畅通，压缩机正常运转。

油冷却器：该冷却器为铝制板翅式结构，冷却风扇强制空气流经冷却器翅片，对冷却器管道中的润滑油进行冷却。在日常维护中，应定期清洗冷却器表面，必要时可用不大于 3.5Bar 的高温压力水冲洗。

2.2.4 压缩机气量调节与控制系统

精灵系列压缩机组配备标准的自动控制系统。

机器开机后先空载运行、10 秒后进入加载状态，根据后端管网的压力调节电机频率。当系统达到卸载停机压力，电磁阀使进气阀关闭，油气分离器内的压缩空气排空，螺杆机空载运行 600 秒（设定值），如无用气，空压机会进入休眠状态，压力低于设定值后，螺杆机重新启动，往复循环运行，使用户的气压不低于设定值。

压缩机组气量调节与控制系统主要由以下元件组成：

进气控制阀、压力调节阀、卸放阀、节流孔、以及连接各元件的管件和接头。

机器的运行主要有三个状态：A. 启动负载运行工况；B. 停机工况；C 待机状态。

一般情况下，压缩机组气量调节与控制系统在出厂时已设定好，用户不必进行调整。如果确需调整，应参阅控制器使用说明书。

机组采用进气节流的气量调节方式，也就是通过控制进气阀的开度来控制压缩机的进气量，从而实现气量调节的目的。机组存在四种工作状态：A. 起动工况； B. 负载运行工况； C. 变频调节运行工况； D. 待机工况。下面以额定压力 8bar (116psi) 的机型为例分别介绍其工作原理，其他额定压力的机组工作依次类推。

警告

不要认为压缩机没有运转而对其进行维护操作是安全的。压缩机可能处于“等待”状态，并可能随时启动。请严格遵循“维修、保养规程”中所有的相关规定。

2.3 电气控制

2.3.1 电气原理图

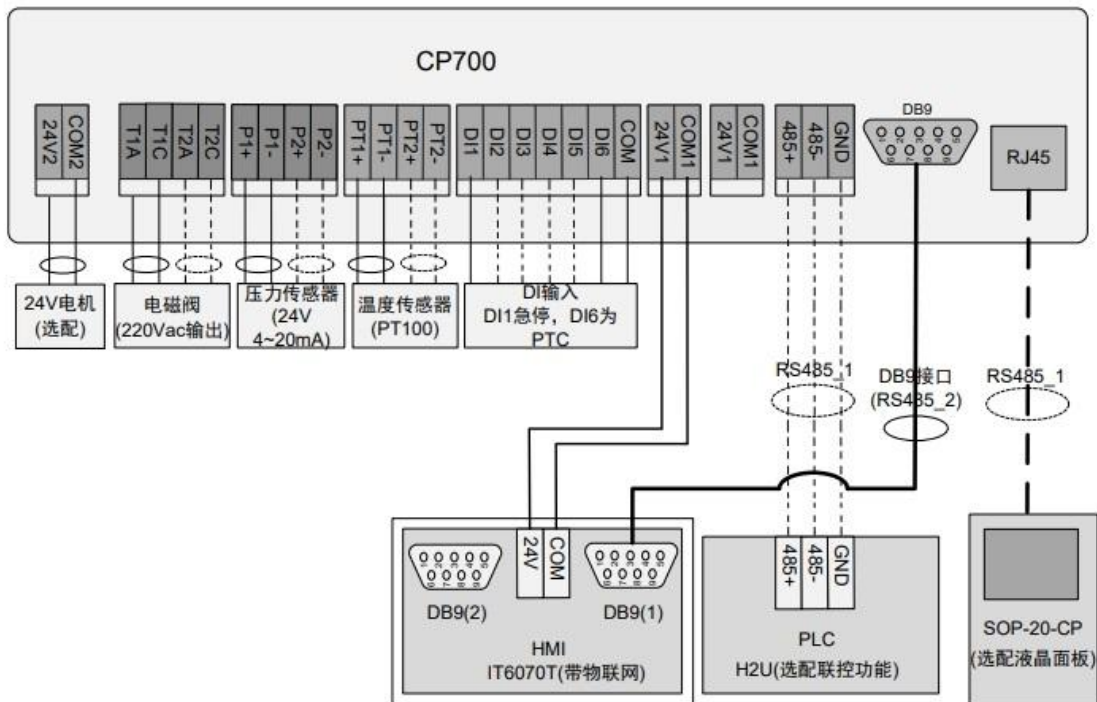

2.4 控制器及功能参数表

2.4.1 控制器按键说明

1. 上电后，HMI 界面自动跳转到如下页面：

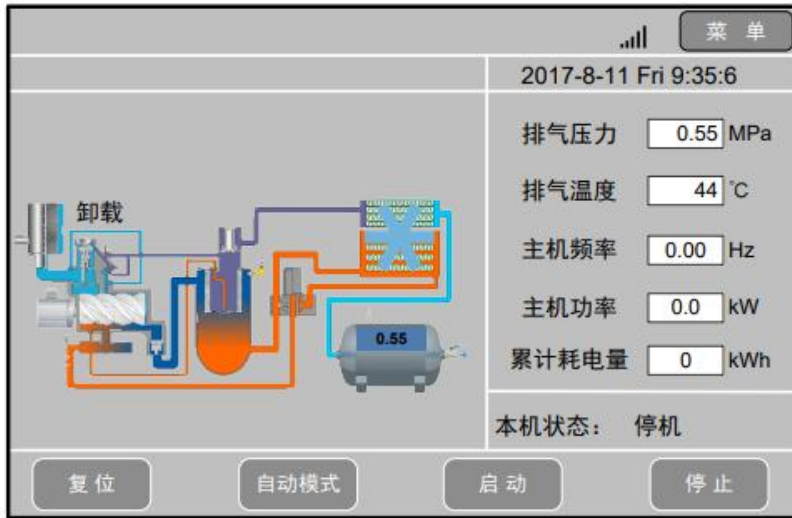

2. 点击右上角的“菜单”按钮，进入界面可以依次点击：主页、运行参数、用户数据、保养参数、保护参数，变频器参数、厂家参数、定时开关机、报警信息、厂家信息：



3. 点击“用户参数”进入下图密码输入框：

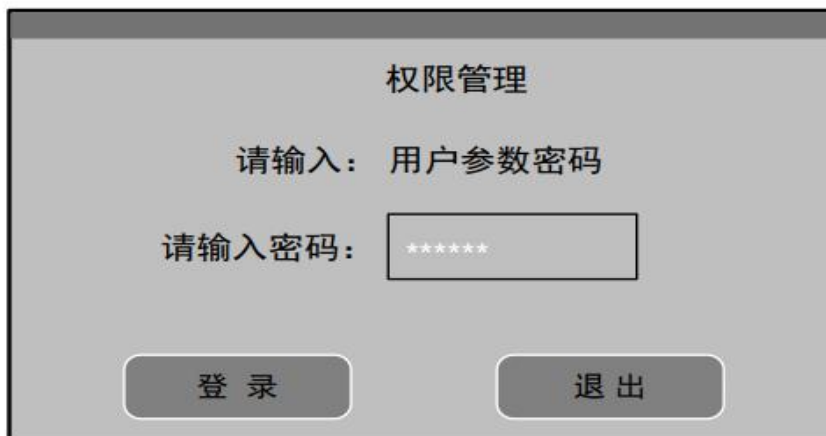

在密码输入框图里面点击一下，进入输入密码：

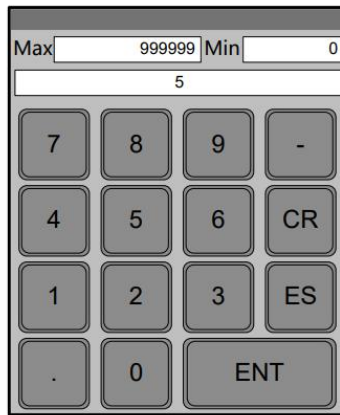

在密码输入正确后，点击 ENT 进入菜单界面，如果输入错误点击 CR，然后重新输入。

“用户参数”界面可以对主机和风机相关参数进行设置。



4. 依次点击“保养参数”，“保护参数”，可以设置空压机相关参数；





5. 设置完空压机参数后，点击“变频器参数”菜单，对变频器参数进行设置：



6. 试运行，分别点击“主机点动”和“风机点动”，观察电机（包括主机、工频风机）运转方向，如果电机运转方向错误，请务必在断电后更改电机 RS 相线序，更改完成后再次选择点动，直到调整到电机运转方向正确。

7. 确认电机运转方向无误后，点击主页上的“启动”按钮，运行空压机。检查运行时的电流及温度是否在正常范围、电磁阀状态是否正确、压力及温度变化是否正常。

8. 关闭空压机，调试结束。

2.4.2 用户参数表及功能

2.4.3 调整参数

调整参数用于设置控制器相关数据，不允许未经厂家授权的用户查看与修改。用户查看调整参数前，需验证调整密码。

一级菜单	二级菜单	设定初值	功能作用
压力、温度预置	预置压力	00.70MPa	变频控制时设置的目标力。
	加载压力	00.60MPa	1, 自动加载模式, 压力低于此值控制器自动加载 2, 待机模式, 压力低于此值, 运行条件具备, 控制器自动启动
	卸载压力	00.80MPa	1, 压力高于此值, 控制器自动卸载 2, 此值要小于或等于“卸载高限”
	风机启温度	0080℃	当排气温度高于此处设置值时, 风机运行。
	风机停温度	0070℃	当排气温度低于此处设置值时, 风机停止。
启停延时预置	启动延时	0010	电机运行延时时间
	加载延时	0002 秒	角运行后, 延时加载时间(适用于工频控制)
	卸载延时	0600 秒	空压机允许的最长连续空载运行时间, 超过此时间后自动停车。
	停机延时	0010 秒	空压机收到停机命令后, 转为空载运行, 空载运行超过此处设定时间后, 自动停机。
	重启延时	0100 秒	正常停机或空车过久停机或故障停机后, 需延时此处设置时间后, 才能重新启动空压机。
维护参数复位	油滤器已用	0000 小时	油滤器累计已使用时间, 更换新的油滤器后, 手动清零。
	油分器已用	0000 小时	油分器累计已使用时间, 更换新的油分器后, 手动清零。
	空滤器已用	0000 小时	空滤器累计已使用时间, 更换新的空滤器后, 手动清零。
	润滑油已用	0000 小时	润滑油累计已使用时间, 更换润滑油后, 在手动清零。
	润滑脂已用	0000 小时	润滑脂累计已使用时间, 更换润滑脂后, 在手动清零。
最大使用时间预置	油滤器预置	500 小时	1, 油滤器累计使用时间超过此处设置值后, 控制器预警; 2, 设为“0000”时, 禁止油滤器预警功能
	油分器预置	500 小时	1, 油分器累计使用时间超过此处设置值后, 控制器预警; 2, 设为“0000”时, 禁止油分器预警功能
	空滤器预置	500 小时	1, 空滤器累计使用时间超过此处设置值后, 控制器预警; 2, 设为“0000”时, 禁止空滤器预警功能
	润滑油预置	500 小时	1, 润滑油累计使用时间超过此处设置值后, 控制器预警; 2, 设为“0000”时, 禁止润滑油预警功能
	润滑脂预置	500 小时	1, 润滑脂累计使用时间超过此处设置值后, 控制器预警; 2, 设为“0000”时, 禁止润滑脂预警功能
用户密码	****	****	可修改的用户密码; 能用旧用户密码或者厂家密码重置

第三章 安装验收

3.1 安装验收及保管:

机器从出厂运输到现场安装就位，停机维护和保养正确与否都关乎设备的完好和正常使用，因此收到机器后应立即检查是否有运输引起的损坏。如发现损坏，可请承运人在装运单据上签字并做出损坏报告。如果当时未及时发现，而是事后发现的隐蔽性损坏，请在收到货物后 15 天内告知承运人，并请承运做出损坏报告，详细的报告对损失的处理（索赔）很重要。

核对压缩机铭牌，以确定该机是否是您所预定的型号和规格，以及选购件是否已包括在内。同时检查油气桶和安全阀，确认其设计或设定压力是否正确。对于暂时不安装或长时间不运转的机组必须设定保护、保养方案确保机组特别是主机头的正常运转。

3.2 安装定位

本系列压缩机组使用于**室内环境**，将压缩机置于环境清洁，通风良好的环境中，地基应坚固，为了安全和便于维修及每天巡查，机器四周必须有足够的空间（在压缩机的四周及顶部至少保留 1.2 米的空间，参见图 3-2 ）。。



图 3-2 安装空间

压缩机工作环境温度不可超过 40°C (104°F)。避免冷却风扇排出的热空气在机房内循环而引起环境温度上升。原则上苏州晨恩所有的固定式螺杆压缩机都是供室内安装使用的，经改装也可以安装在室外一些场合，应避免雨水，雪和冰冻。

⚠️: “警告”

压缩机不能在 0°C (32°F) 以下或高于最高使用温度上限的环境下工作。

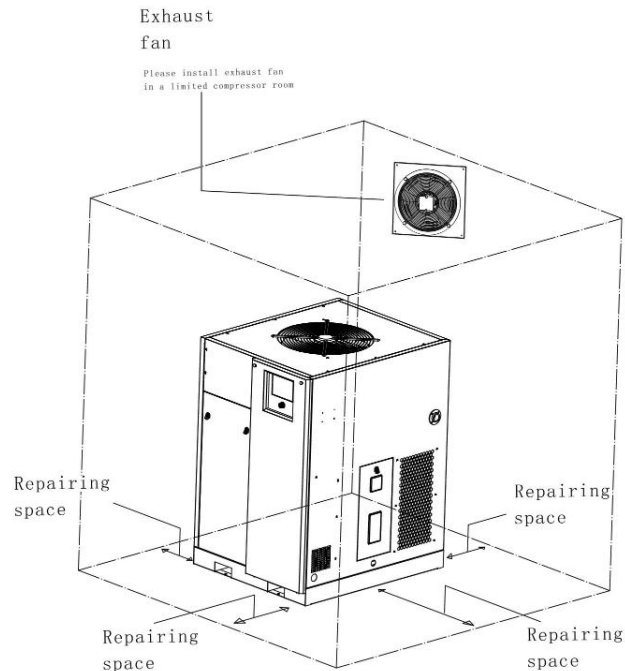
⚠️: “注意”

压缩机正常运转需要足够的清洁空气

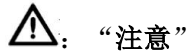

“注意”

拆除或改动隔音罩会产生高噪音从而危害人体健康。

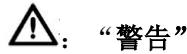

“警告”

不要将压缩机安装或暴露在有毒，挥发性或有腐蚀性气体的场合，也不可以在其附近储藏类似性质的物质，否则会引起严重的人员伤亡和财产损失。

有关压缩机房的设计，安装和使用请参阅 GBJ29-90 《压缩空气站设计规范》。

3.3 整机存放和保养

当机组长期放置或长时间停止运转时，首先必须确保安置环境清洁、干燥，放空油气储气罐，冷却器（特别是水冷却器），管路水过滤器等零部件底部的积水，定期对机组各主要零部件、接头进行检查，清洁确保无泄漏和生锈现象，至少每个月开机运行不少于 60 分钟以确保主机头的安全润滑；其次在开机前认真检查，必要时更换机组润滑油，并对机组进行 2 小时的满负荷运行测试，记录数据，并请具有资格的专业服务工程师进行指导。

3.4 安装、配管及电气配线

在任何情况下，管道尺寸不应小于压缩机排出管道的连接尺寸。

对于压缩机而言，空气过滤器是必不可少的，应选择能提供清洁空气的气源。

3.5 配管、基础及冷却系统注意事项

3.5.1 空气管路的配管注意事项

- 1) 管路配管时，管路须有 1-2 度之倾斜度，以利管路中的凝结水排出。
- 2) 配管管路的压力降不得超过空压机设定压力的 5%，最好选用较设计值大的管径。
- 3) 支线管路必须从主管路的顶端接出，避免管路中的凝结水下流至工作机器中或者回流至空压机内。
- 4) 主管路不要任意缩小，如果必要缩小或放大管路时须使用渐缩管。气体在管内流动时，在直线管段产生摩擦阻力；在阀门、三通、弯头、变径管等处产生局部阻力，从而导致气体压力损失。一段管路长度内的压力降可从表 3-1 中查取：

表 3-1：流量-配管压力降 Kg/cm²-(100m)

流量 m ³ /min	管径 (mm)					
	DN15	DN20	DN25	DN32	DN40	DN50
0.8	5.87	1.23	0.339	0.0858	0.038	
1.0	9.18	1.92	0.53	0.134	0.059	0.0157
1.6	23.5	4.9	1.36	0.343	0.152	0.0428
2.0		7.66	2.12	0.536	0.237	0.0668

说明：

- 1、直管段实际压力降=表值×管长/（100×压缩比）。（压缩比=表压力+1）
- 2、管路部分压力降还应加上弯头、异径接管、三通接头、阀门等产生的局部压力损失，这些值可从有关手册上查得。
- 3、空压机后处理配套（冷干机、吸干机、过滤器）选型，参见表 3-2。精密过滤器，C 系列离心式油水分离器，T 系列主管路过滤器，A 系列微油雾过滤器。H 系列活性吸附过滤器，主要应用于食品、医药及药物工厂。
- 4、系统压力在 1.5MPa 以下的压缩空气，其输送管内的流速须在 15m/sec 以下，以避免

过大的压力降。

5、管路中尽量减少使用弯头及各类阀门，以减少压力损失。

3.5.2 空压房通风的注意事项



图 3-3 室内通风

压缩机机房狭窄时，请在压缩机排风口侧墙高出设置排风扇，并将进气口设在进气侧墙壁的低矮处（参见图 3-3 A 图）。压缩机安装在宽敞的厂房时，请选择通风良好的位置进行安装（参见图 3-3 B 图）。

3.6 安全设施安装

3.6.1 安全阀（泄压阀）

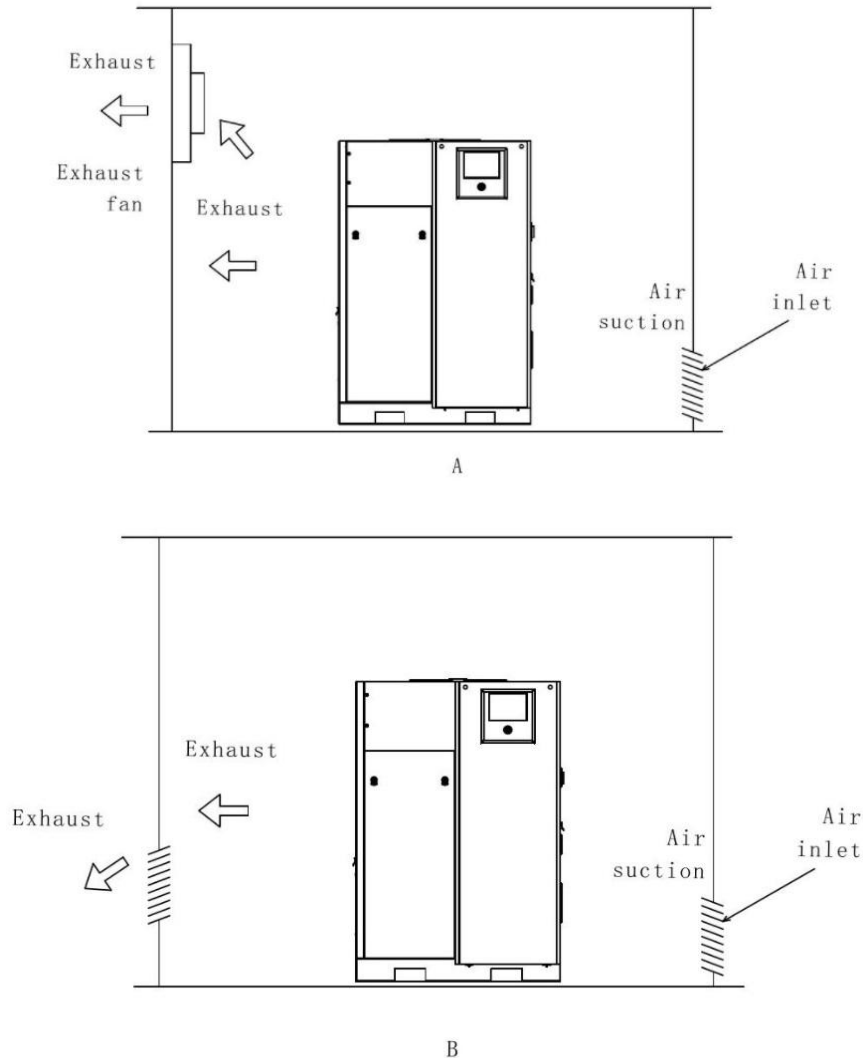
安全阀是用于保护系统的泄压装置，在出厂时已设置好，不可随意更改其压力设置或堵塞此阀。只有安全阀制造商或合格的代理商才能进行此项工作。应将安全阀排出的气体引到远离人群的安全之处。

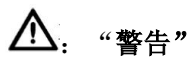

不可更改，焊接，维修或再加工 GB（或 ASME）规范的压力容器，也不允许在超过铭牌额定值的条件下使用，否则将影响保险条款，并导致严重的人员伤亡和财产损失。

3.6.2 防护罩

所有的机械运动均存在不同程度的危险，故应设防护罩。本系列机组完全按照国家、行业标准装置了必须的防护设施，用户应定期进行检查，维护，不可随意更改或拆除。

3.6.3 手动放空阀和截止阀

建议在客户空气系统中安装一个手动放空阀，安装手动放空阀的目的是为了将压缩机及其排气管道中的空气排放到大气中去。当系统储气罐仅与单台压缩机配套使用时，可将放空阀安装在储气罐上，如果系统中安装了截止阀，手动放空阀就应当安装在截止阀上游，如此配置确保维修及保养时人员和设备处于安全状态。

如果仅仅为了将压缩机从系统中隔离出来以便维修，请注意切勿以止回阀来取代截止阀。

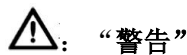

“警告”

在维修机器前必须打开手动放空阀，排空压缩机及系统中的压力，在系统降压上的疏忽可能导致严重的人身伤害，死亡和财产损失。

3.7 电气安装

安装前，应检查电源、电源线和变压器容量是否相符，在安装中应配有合适的熔断器或断路器。电压相位之间的不平衡须限制在 5% 以内，以防止因为低电压造成过电流。用户电源线及空气开关选型，具体参见表 3-3，用户空气开关电流规格按总电流的 1.5-2 倍选取。压缩机必须很好的接地，参见电气接线图。

表 3-3：用户电源线及空气开关选型

额定功率 (kW)	线电流 (A)	客户电源线径 40℃载流量计算	用户空气开关规格 不小于以下电流 (A)
11	20	3*4mm ² + 2.5mm ²	40
15	28	3*6mm ² + 4mm ²	63
18.5	35	3*10mm ² + 6mm ²	80
22	43	3*10mm ² + 6mm ²	80
30	58	3*16mm ² + 10mm ²	125
37	65	3*16mm ² + 10mm ²	125
45	80	3*25mm ² + 16mm ²	160
55	97	3*35mm ² + 25mm ²	200
75	124	3*50mm ² + 35mm ²	250

注：

如果配电柜距离空压机较远，则需相应增加线径，防止产生过大电压降影响机器运行。

3.8 接线示意图:

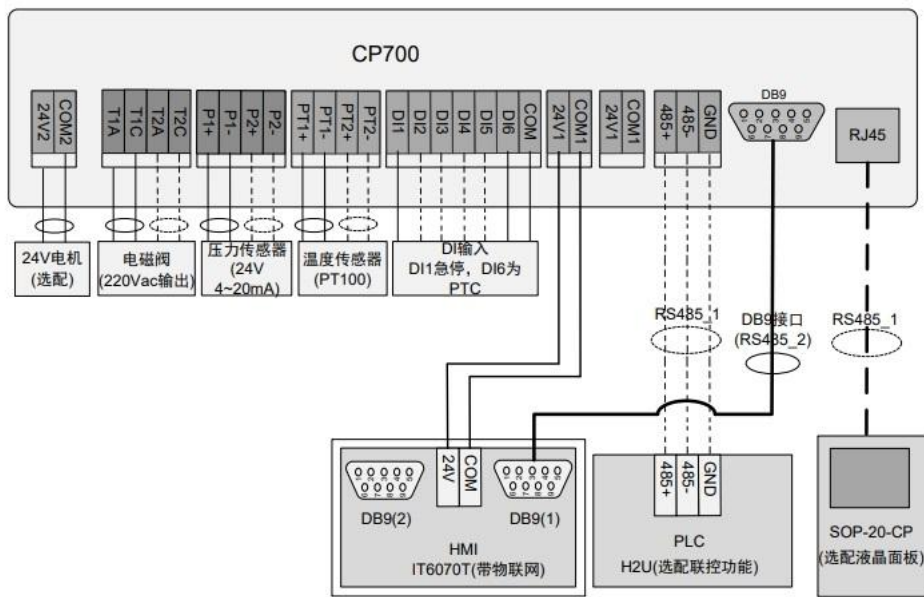

第四章 操作规程

4.1 概述

本系列螺杆压缩机组配置有一系列的控制元件和显示/指示元件。为确保机组的正常运行，需要操作人员能够正确操作机器，还需要操作人员能够根据显示/指示的数值或状况对机组的运行状况或故障情况作出正确的判断。在起动机组之前，操作人员要熟悉控制/操纵元件和显示/指示元件的位置、作用和用法。具体参阅控制器使用手册。

4.2 准备启动

- 1) 移去压缩机周围的杂物与工具。
- 2) 拆除运输固定用螺栓或装置。
- 3) 检查油位，确保其处于正常位置（见润滑油章节）。
- 4) 检查风扇，确保其安装牢固。
- 5) 检查所有压力管道接头是否牢固，无松动。
- 6) 打开供气阀门。
- 7) 检查并确保安全阀是否安装到位。
- 8) 检查所有罩板和防护装置是否安全并牢固。
- 9) 检查保险丝，断路器或控制器电流设置是否适合，设置是否正确。
- 10) 检查空气滤清器是否安装可靠。
- 11) 合上电源开关，屏幕灯亮。点动启动按钮，确保压缩机转向与规定转向一致。
- 12) 冷感机一体机（C5F）请打开冷干机开关

4.3 常规起动步骤

- 1) 打开通向供气系统的截止阀门。
- 2) 预设好控制参数后按启动按钮。
- 3) 观察启动后的压缩机是否有异常振动、噪音，气/油渗漏，若发现问题，请立即停机进行改正。
- 4) 关上所有的隔音罩门，以控制机组的噪声，保证冷却空气的正常流动。
- 5) 缓慢关闭供气截止阀，检查机组是否按设定卸载，参见第六章工况参数设定及调整。
- 6) 检查各状态参数指示值是否正常。
- 7) 压缩机运行的第一个小时请仔细观察运行情况，以后七小时随时进行观察，若有异常，请停机检修。
- 8) 初次运行后，按停机程序停机，检查油箱是否需要加注润滑油；检查各连接处是否有松

动。  “注意”：

- ①要定期放出油气桶底部的冷凝水。放出冷凝水的操作应在起动机组前进行。
- ②要定期（每周）放出控制管路过滤器底部的冷凝水。放出冷凝水的操作应在起动机组前进行

4.4 停机程序

- 4.1. 按停止按钮。
- 4.2. 关闭通向供气系统的截止阀。
- 4.3. 切断电源开关。



“注意”：停机时关闭截止阀可避免由于止回阀的损坏而导致供气系统的压缩空气倒流回压缩机引起泄漏和机件的损坏。急停停机：在非正常情况下按急停/复位开关停机，并切断电源开关。

第五章 维护保养

5.1 维修保养前的准备

为确保机组正常运行和有长的使用寿命，良好的维护保养是关键。因此，必须认真地执行螺杆压缩机组的维护保养规程。在着手进行维护之前，请认真阅读本手册第一章 **安全规则**，至少做好以下准备：

- 1) 切断主机电源并在电源开关处挂上标志。
- 2) 关闭通向供气系统的截止阀以防压缩空气倒流回被检修的部分。
- 3) 打开手动放空阀，排空系统内的压力，保持放空阀处于开启状态。
- 4) 确保压缩机组已冷却，防止烫伤、灼伤。
- 5) 擦净地面油痕、水迹以防滑倒。



“警告”

- 不要以为机器停机，就认为可以进行检修，保养工作，机器的自动控制系统随时会启动压缩机。
- 不良的维护保养不仅影响机组的正常运行，而且还可能影响操作人员的安全。
- 在压缩机运行或带压时，不要拆卸螺母、加油塞以及其它零件。
- 不可使用可燃性溶剂，如汽油或煤油清洗空气过滤器或其他零部件。应该按说明使用安全溶剂。

5.2 螺杆压缩机的维护保养



“注意”： 只要经过培训而且合格的维修人员才有资格对机器进行维护保养。

5.2.1 空滤芯更换：

1. 拧下空滤外壳顶部燕尾螺丝



2. 抽出旧的空滤芯，装入新滤芯后外壳复原



5.2.2 冷却油更换:

1. 准备容器，拆下放油堵头放出旧冷却油
然后堵头复原

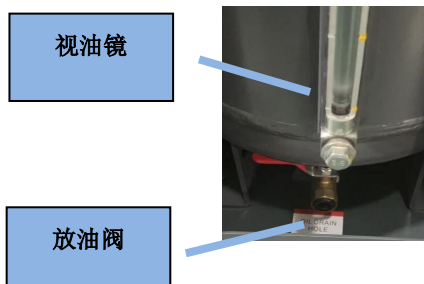

2. 打开加油堵头加入专用冷却油，
至观油镜 2/3 至 3/4 位置后复原堵头

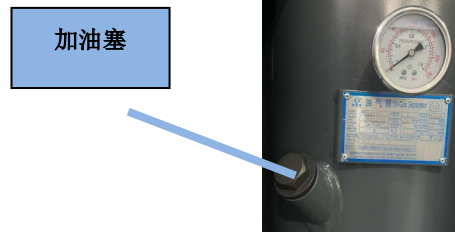

5.2.3 油过滤器、油气分离器更换:

1. 用皮带扳手或专用扳手拆下旧品
2. 清洁安装表面，在新品密封圈上涂一薄层同品名冷却油
后用手预紧，再用扳手紧固

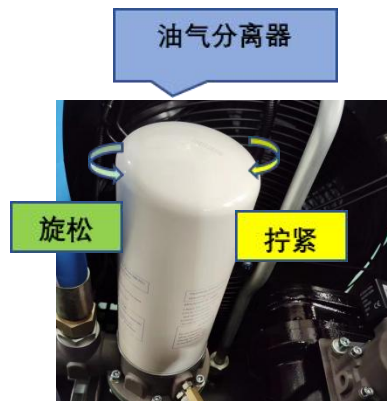
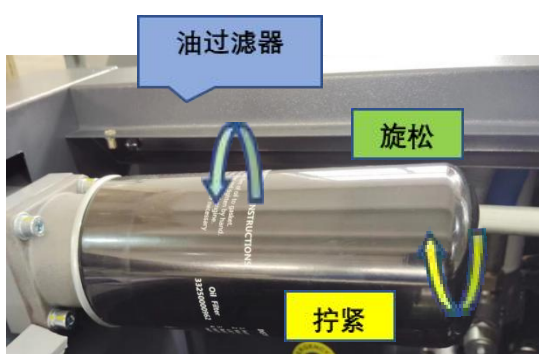

5.3 保养提示及保养后更新设置方法:

在控制面板修改“已使用时间”，在本次保养结束后可清零，系统将自动重新开始计时。

5.4 保养计划

周期(小时数)	推荐操作	备品备件套装
每周	检查润滑油位 清洁空气过滤器 清洁散热器（外表） 储气罐排污 螺杆机内部清洁、除尘	保养
500	更换螺杆机专用润滑油 更换油滤 更换油细分离器 更换空气过滤器滤芯 检查控制开关电缆螺丝 检查密封（各接头、气管） 清洁散热器（外表） 储气罐排污 螺杆机内部清洁、除尘	备件咨询生产厂家
3000	更换螺杆机专用润滑油 更换油滤 更换油细分离器 更换空气过滤器滤芯 检查控制开关电缆螺丝 检查密封（各接头、气管） 清洁散热器（外表） 储气罐排污 螺杆机内部清洁、除尘	备件咨询生产厂家
5000	（除了每 2000 小时保养项目） 更换机封轴 清洁油气分离器油污 清洁回油单向阀（必要时更换） 清洁进气阀（必要时更换） 清洁最小压力阀（必要时更换） 控制（最终改变）电机轴承 清洁散热器（内、外）	备件咨询生产厂家
20000	（除了每 8000 小时保养项目） 更换主机轴承	备件咨询生产厂家

本保养计划是基于制造商推荐的所有安装和操作参数。制造商建议设置压缩机维护工作日志，以便后期保养维护。表中所示操作小时数指机器的最佳使用状态，根据工作场所和周期数可能发生变化。

5.6 常见故障排除表（手动检查时需断电、断气）

问题	原因	解决方案
油温过高导致停机	机体的排气温度过高（最大105℃）	<ul style="list-style-type: none"> - 检查油位； - 检查冷却器的清洁 - 检查风扇是否正常工作 - 检查温度传感器是否正常工作 <p>重新启动机器前必须按下复位按钮。如果重复出现高温，请联系服务中心</p>
电机过热导致停机	<ul style="list-style-type: none"> - 电压过低。 - 电机温度过高 - 功率消耗过高 	<ul style="list-style-type: none"> - 如果故障发生时，机器开启中，检查相序是否稳定； - 如果故障发生时，机器运行中，确认内部压力并更换油细分离器 - 如果电机的电流高于额定电流，请联系服务中心的技术人员。 - 不要强制启动，以免对压缩机的控制板造成更多的损坏。 - 检查电压、频率是否匹配
安全阀打开	<ul style="list-style-type: none"> - 压力传感器失效 - 设定压力超过安全阀的设定值 - 油细分离器堵塞 	<ul style="list-style-type: none"> - 检查压力传感器与气压表参数是否正常 - 检查控制面板设定值与安全阀参数是否匹配 - 更换安全阀 - 拆更换油细分离器
压缩机运行但是压力过低	<ul style="list-style-type: none"> - 进气阀未打开。 - 泄露造成压力无法增加 - 传动元件阻断 	<ul style="list-style-type: none"> - 在空压机停机，且内部压力安全的情况下，移去空滤，并检查气门是否能移动 - 检查管路是否存在泄漏 - 仔细检查是否存在电机运转，但是机体不运转的情况。 - 联系服务中心
空气过滤器喷油	<ul style="list-style-type: none"> - 油位过高 - 回油窥视镜脏 - 油细分离器故障 - 进气阀泄放过快 	<ul style="list-style-type: none"> - 停机时将多余的油排除，并检查油位。 - 拆下回油窥视镜清洁，如有必要更换。 - 更换油细分离器，并清洁芯管。

主电机过载	<ul style="list-style-type: none"> - 电压低 - 电源缺相 - 油气桶压力高 	<ul style="list-style-type: none"> - 确认输入电源 - 检查电源的三相输入是否相近数值，且是否可靠 - 接到接线端子 <ul style="list-style-type: none"> - 检查线缆是否有损坏 - 确认主电机的通风是否通畅。 - 如果电机只有两相输入，由资质的技术人员检查。（如果有必要，更换或修理电机） - 如果油气桶的压差大于 1bar 将造成系统的高能耗。由资质的技术人员检查系统。 - 环境温度过高：通风 - 重新启动机器，按下控制板上的复位开关。
油耗过量	<ul style="list-style-type: none"> - 油细分离器故障油不适合压缩机。 - 空气/油分离器滤芯损耗或缺陷。 - 油位过高。 	<ul style="list-style-type: none"> - 换油，向机器中注入制造商指定用油。 - 更换油细分离器。 - 清洁或更换回油窥视镜。 <p>补充油直至油位达到手册指定的正确位置为止。</p>

5.7 螺杆配件爆炸示意图

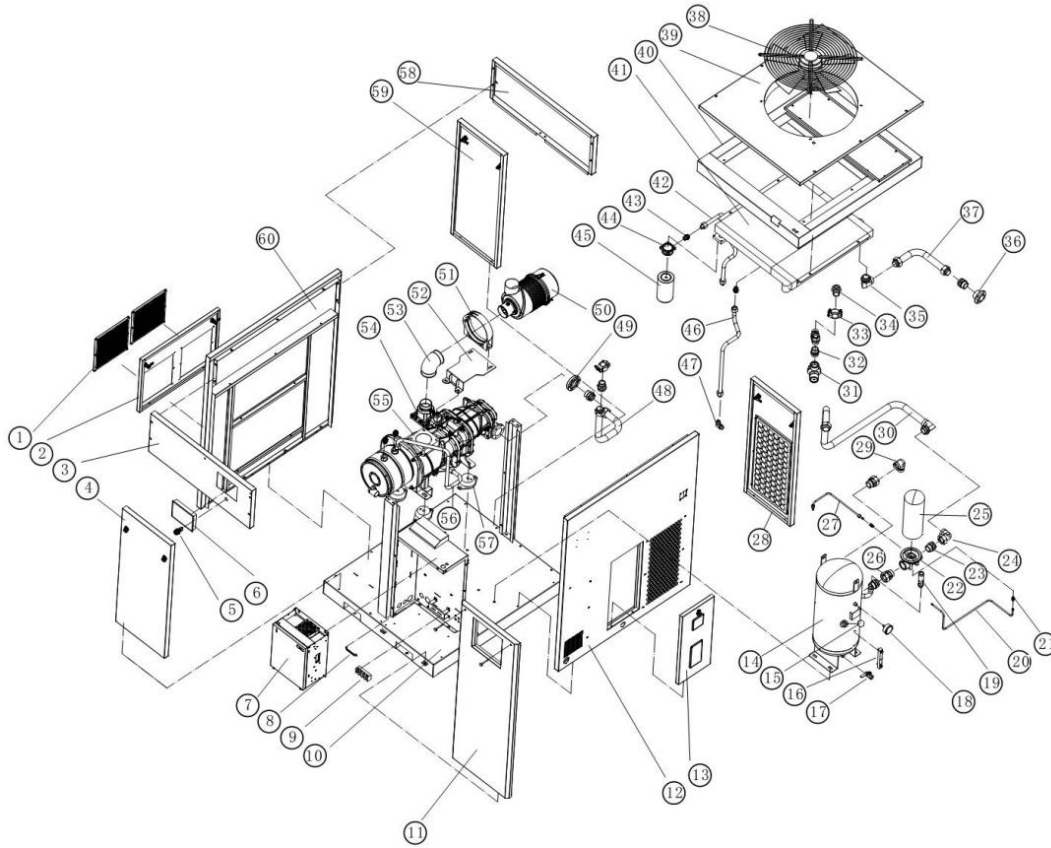

序号	零件名称	数量	序号	零件名称	数量	序号	零件名称	数量
1	过滤网	2	26	直接头G1-1/2-M52X2 (螺帽)	1	51	空滤抱箍	1
2	左活动门板	1	27	二次回油管	1	52	空滤支架	1
3	前上固定门板	1	28	后下右门板	1	53	空滤弯头	1
4	前左下门板	1	29	弯头M52X2-DN32	1	54	进气阀	1
5	急停	1	30	冷却器进气管	1	55	螺杆主机总成	1
6	控制面板	1	31	最小压力阀	1	56	油冷电机出油管	1
7	变频器	1	32	接头G1-1/4-M45X2	1	57	减震垫	4
8	地线排	1	33	抱箍DN32	2	58	后上门板	1
9	排线端子	1	34	直接头M52X2-DN32	2	59	后下左门板	1
10	底座	1	35	弯头G1-1/2-M52X2	1	60	左门板	1
11	前右门板	1	36	排气法兰G1-1/2	1	61		
12	右门板	1	37	冷却器出气管	1	62		
13	右活动门板	1	38	风机	1	63		
14	油桶	1	39	顶盖	1	64		
15	加油堵头	1	40	导风罩	1	65		
16	油镜	1	41	冷却器	1	66		
17	排污阀	1	42	冷却器出油管	1	67		
18	压力表	1	43	直接头G3/4-M30X2	5	68		
19	安全阀	1	44	油滤座	1	69		
20	卸荷管	1	45	油滤	1	70		
21	直接头G1/4-M14X1.5	1	46	冷却器进油管	1	71		
22	油分座	1	47	弯头G3/4-M30X2	1	72		
23	直接头G1-1/2-M52X2	1	48	主管	1	73		
24	弯头M52X2 (螺帽)	1	49	主机法兰G1-1/2	1	74		
25	油分	1	50	空滤总成	1	75		

Chapter 1 Safety Rules

Safety warning signs

In this manual, the operations and matters involving safety are defined and classified according to the severity of damage to the machine and the degree of personal injury that the operation may cause, and the following signs are used to express and explain in bold.

 接地	"Warning" means that you must confirm that it is properly grounded before starting the machine.
	"Caution" indicates unsafe factors that may cause general damage to the machine or personal injury.
	"Warning" indicates unsafe factors that may cause property damage or personal injury.
	"Warning" means electrical equipment, and only qualified personnel can operate in accordance with the specifications.
	"Warning" means that the unit will restart automatically, which may cause serious injury to the human body and equipment.
	"Warning" means do not touch the surface of hot objects. To prevent burns, please do not approach this surface.
	"Warning" means that moving parts can cause serious injury to the body. Do not operate the equipment without a protective cover or when the protective cover is damaged.
	"Danger" refers to unsafe factors that can cause major accidents or personal injury.
	"Danger" means an unsafe factor that can cause serious personal injury or death with a voltage exceeding the safety level. All electrical work must be done by a qualified electrician.
	"Dangerous" means that it is used for breathing and food handling. The compressed air must comply with the standards OSHA 29CFR1910.134 and FDA 21CFR178.3570, otherwise it will cause human injury and even death.
	"Dangerous" means that the pressurized gas will cause serious damage to the human body, equipment and property, or even death.
	"Caution" means unsafe factors that may cause property damage or personal injury to hot surfaces.
	"Attention" indicates important installation, operation and maintenance information.

Safety warning

Be sure to read carefully before operating and using the compressor



Compressed air and compressed air systems are dangerous!

Failure to comply with the operating procedures and safety precautions of this operating manual may cause accidents and cause the possibility of injury or death to yourself or other personnel!

Before operating and maintaining the compressor, you must carefully read and understand this operation manual!

Before the machine leaves the factory, obvious warning decals have been affixed to dangerous places and places that require attention.

Before performing any operation and maintenance on the unit, you must read and understand this operation manual.

1. The unit must not be operated at an exhaust pressure higher than the rated exhaust pressure of the unit, otherwise the motor will be damaged due to overload.

2. When the unit leaves the factory, various protection controls are set up intact, and the control components of the unit must not be changed or dismantled at will, otherwise it will cause serious equipment and personal injury accidents

3. When the unit is running, never disassemble or loosen any pipeline components, joints, plugs and couplings, and do not pull the safety valve. The unit is full of hot working fluids under pressure, which can cause serious personal injury accidents.

4. Before performing any maintenance work on the unit, you must confirm:

The unit has stopped;

The internal pressure of the unit has been completely vented;

The power is turned off.

5. Only safe solution can be used to clean the compressor and auxiliary equipment of the unit.

6. Once any part fails, it must be replaced immediately, otherwise it may cause immeasurable losses.

7. This machine is for indoor use and cannot be used in the open air. Must be grounded ★★★

The safety measures and safety precautions listed below are only part of the matters that must be observed when using the compressor and compressed air system, but not all of them.



Failure to observe the following safety measures will result in personal injury or death, property damage or compressor damage.

Only trained and authorized persons can operate the compressor. Before any work, you should read this operation manual carefully and fully understand its contents. Failure to follow the operation and maintenance procedures and safety rules in the operation manual may cause accidents and personal injury.

Never start the unit under unsafe conditions; if there is a problem with the unit, do not try to start it. The power supply should be cut off and an obvious sign should be made to prevent unknowing people from misoperation.

Compressed air is dangerous, and the unit can be repaired and maintained only when the compressed air in the entire compressor system has been emptied.

Do not change the internal structure and control method of the unit unless it is approved in writing by Suzhou Chanunsi Keluo Company.

If it is a unit with movable wheels, please make sure that the wheels have been secured by effective measures before starting the machine.

Do daily maintenance and maintenance. The unit should be carefully checked every day to see if there is any leakage, loose parts, damage, adjustment failure or missing parts, etc., and deal with problems in time.

Chapter 2 System Function Introduction

2.1 Introduction

The Elf series permanent magnet inverter compressor designed and manufactured by Suzhou Chanun is a positive displacement, oil-injected twin-screw compressor. The motor and the male rotor of the compressor head are integrated to drive the compressor to rotate. The unit has good power, economy and reliability.

This unit has reasonable layout, complete functions, simple operation and maintenance, and beautiful appearance. All instruments, indicators and control devices are concentrated on the control panel, which is easy to operate and can run stably and reliably for a long time, see Figure 2-1. In order to keep the screw compressor unit you have purchased or used in the best operating condition, please read Chapter 5 Maintenance in this operation manual carefully.

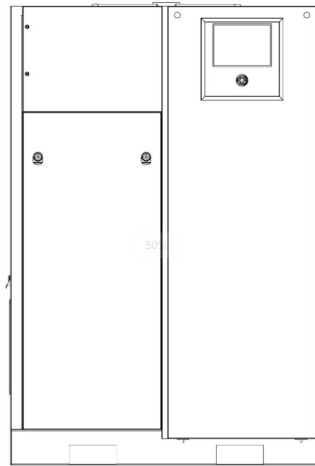
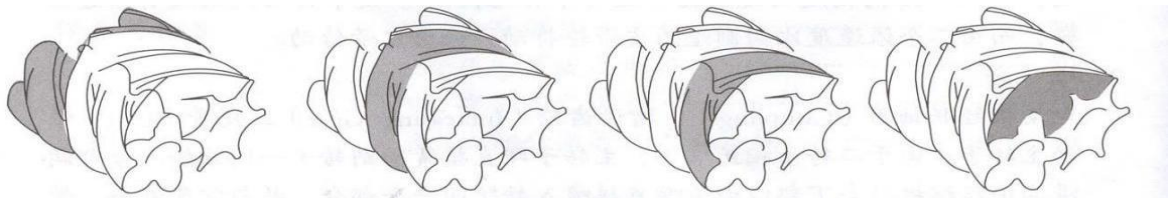

diagram 2-1

2.2 Compressor head and compression cycle

Compressor head (host). Refer to Figure 2-2. When working, air enters the casing through the air inlet at the power input end. When the rotor turns over the edge of the suction orifice on the casing, a part of the sucked air is enclosed in the female and male rotors and in the enclosed volume of the screw groove formed by the casing, the enclosed volume of the screw groove changes continuously with the meshing movement of the female and male rotors, so as to realize a continuous working cycle of suction, sealing, compression, and exhaust. The compressed air passes through the exhaust port. Exhaust into the oil and gas barrel.



1. Inhalation process 2. Closed and conveyed 3. Compression and fuel injection stroke 4. Exhaust process

Figure 2-2 Compression cycle

2.2.1 Air intake system

Refer to Figure 2-3. The function of the air intake system of the compressor unit is to provide clean air to the compressor. It includes an air filter and an air intake valve.

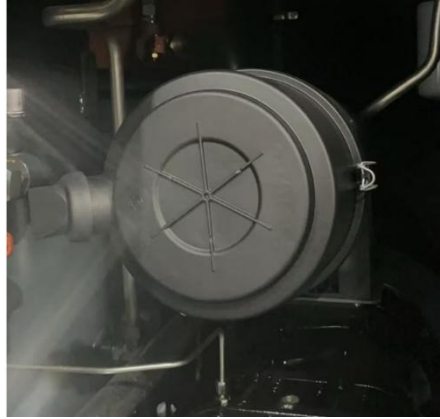

Figure 2-3 Air intake system

2.2.2 Compressor exhaust system

The exhaust system of the compressor unit is mainly composed of oil and gas barrels, gas storage tanks, combination valves, oil separators, safety valves, etc.

The oil and gas barrel part can realize the phase separation of the mixture of oil and gas. An oil fine separator is installed above the oil and gas barrel. The compressed air after the oil and gas separation contains only a few PPM (usually below 3PPM) of lubricating oil. On the left side of the tank is the gas storage tank, which acts as a buffer and has a good protective effect on the air compressor. It can filter out part of the condensed water, and it also has the function of reducing the gas exhaust temperature, which can reduce the dryer load.

The gas storage tank is located under the machine to store gas.

The combined valve integrates the oil fine separator seat, the oil filter seat, the pressure maintaining valve, and the safety valve interface. The function of the pressure maintenance valve is to ensure that the compressor establishes a minimum tank pressure in the system during normal operation to ensure the normal operation of the lubricating oil circuit. When the unit is shut down, the pressure maintaining valve is a check valve to prevent the compressed air from returning. The opening pressure of the pressure maintenance valve is $4.0 \pm 0.34 \text{ bar}$ ($60 \pm 5 \text{ psi}$), which has been preset before leaving the factory.

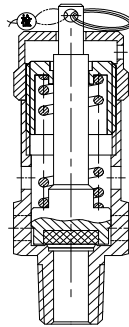

Figure 2-5 Safety valve

There is a safety valve for the oil and gas barrel and the gas storage tank on the barrel. When the gas pressure in the tank exceeds the set pressure of the safety valve, the safety valve will open automatically. The opening pressure of the safety valve has been set before leaving the factory, please do not change it without authorization.



warn

- When the compressor is running or under pressure, do not disassemble nuts, oil plugs and other parts. Shut down and release all internal pressure before maintenance operations.
- It is not allowed to replace and use other types of safety valves.

2.2.3 Compressor cooling and lubrication system

The compressor cooling and lubrication system consists of an oil and gas barrel, an oil cooler, a combination valve, an oil filter and an oil pipeline, etc.

The oil filter consists of a filter seat and a replaceable spin-on filter element with a built-in bypass valve. When

the filter element is dirty or the oil viscosity is too high, it can ensure the smooth flow of the oil path and the normal operation of the compressor.

Oil cooler: The cooler is an aluminum plate-fin structure. The cooling fan forces air to flow through the cooler fins to cool the lubricating oil in the cooler pipe. In daily maintenance, the surface of the cooler should be cleaned regularly, and if necessary, it can be flushed with high-temperature pressure water not greater than 3.5Bar.

2.2.4 Compressor air volume adjustment and control system

The Genie series compressor unit is equipped with a standard automatic control system.

After the machine is turned on, it runs at no-load and enters the loading state after 10 seconds. The motor frequency is adjusted according to the pressure of the back-end pipe network. When the system reaches the unloading stop pressure, the solenoid valve closes the intake valve, the compressed air in the oil-air separator is emptied, and the screw compressor runs without load for 600 seconds (set value). If there is no use of air, the air compressor enters a sleep state. After the pressure is lower than the set value, the screw compressor restarts and runs reciprocatingly so that the user's air pressure is not lower than the set value.

The air volume adjustment and control system of the compressor unit is mainly composed of the following components:

Intake control valve, pressure regulating valve, discharge valve, orifice, and pipe fittings and joints connecting various components.

The operation of the machine mainly has three states: A. Start load operation condition; B. Stop condition; C standby state.

Under normal circumstances, the air volume adjustment and control system of the compressor unit has been set at the factory, and the user does not need to make adjustments. If you really need to adjust, you should refer to the controller instruction manual.

The unit adopts the air volume adjustment method of air intake throttling, that is, by controlling the opening of the intake valve to control the air volume of the compressor, so as to achieve the purpose of air volume adjustment. The unit has four working conditions: A. Starting conditions; B. Load operating conditions; C. Frequency conversion regulating operating conditions; D. Standby conditions. The following takes a model with a rated pressure of 8 bar (116 psi) as an example to introduce its working principle, and the work of units with other rated pressures can be deduced by analogy.



Do not think that the compressor is not running and it is safe to perform maintenance operations on it. The compressor may be in a "waiting" state and may start at any time. Please strictly follow all relevant regulations in the "Repair and Maintenance Regulations".

2.3 Electrical control

2.3.1 Electrical schematic diagram

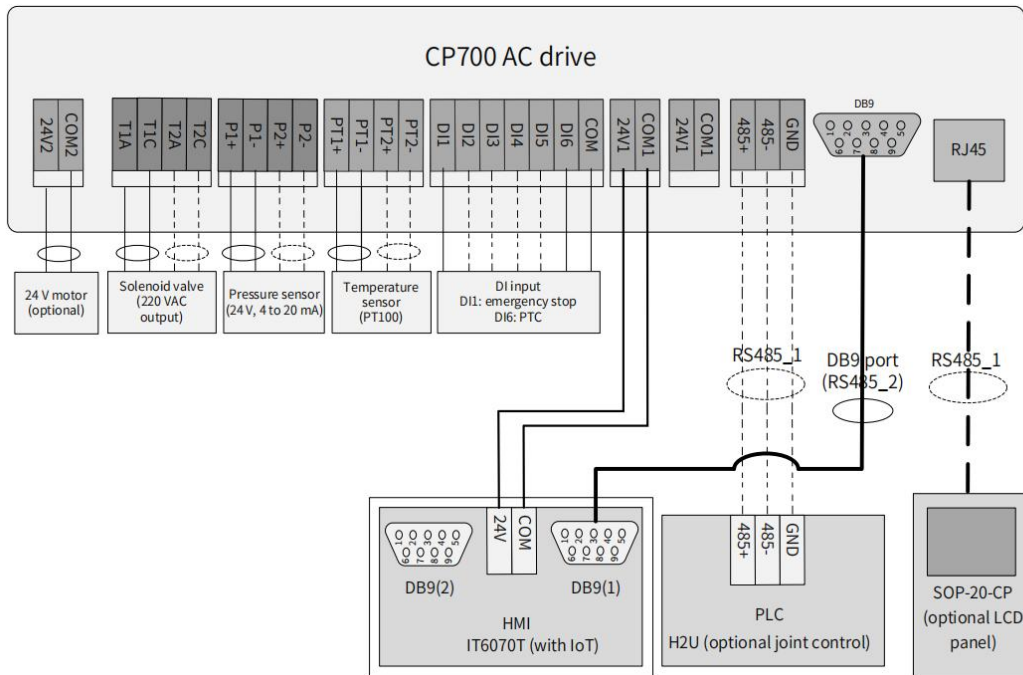

2.4 Controller and function parameter table

2.4.1 Controller key description

1) When power is on, HMI display automatically switches to the following page.

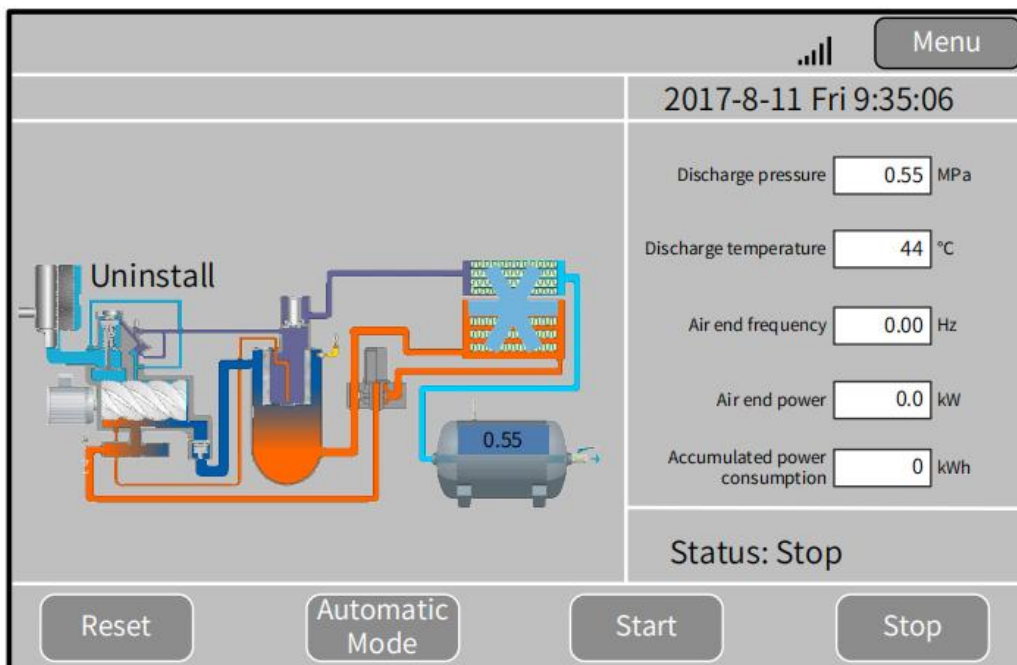

2) Touch "Menu" in the upper right corner of the main page to access the page shown in Figure 3-4. Touch "Homepage", "Running Data", "User Parameters", "Maintenance Parameters", "Protection Parameters", "AC Drive Parameters", "Manufacturer Parameters", "Timing Switch", "Alarms", and "Manufacturer Information" in sequence to view more details.

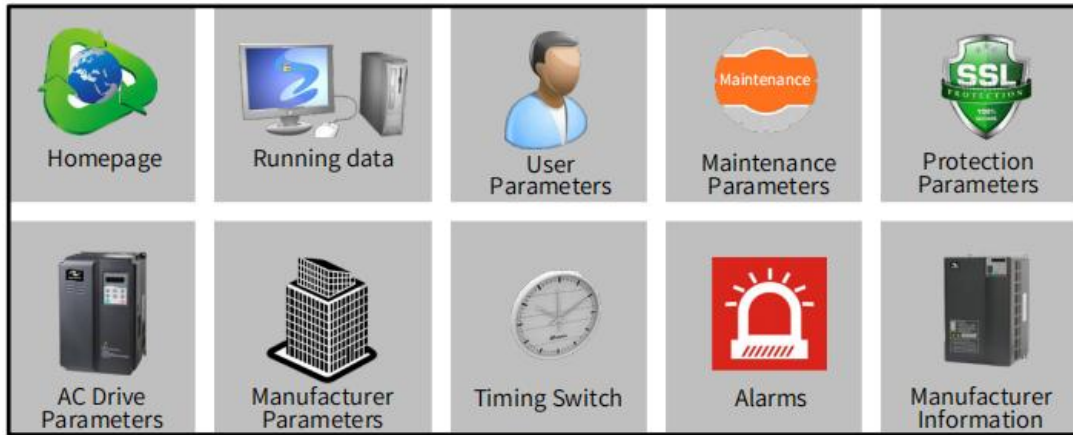

3) Touch "User Parameters" to open the "Rights Management" dialog box for password setting.



Touch the password input box to enable the digit keypad and enter a password, as shown in Figure 3-6.

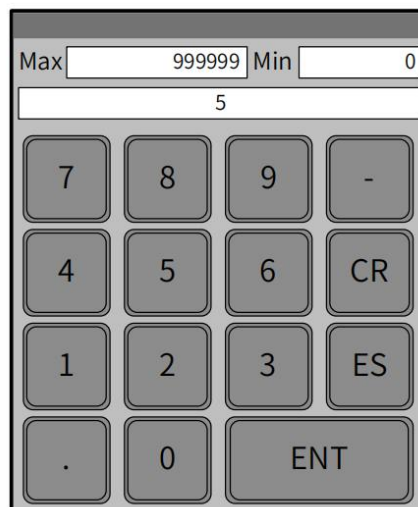



◆ After entering a correct password, touch "ENT" to open the "User Parameters" page, as shown in Figure 3-7. If an incorrect password is input, touch "CR" and enter the password again.

On the "User Parameters" page, set parameters related to the compressor air end and cooling blower, as shown in Figure 3-7.

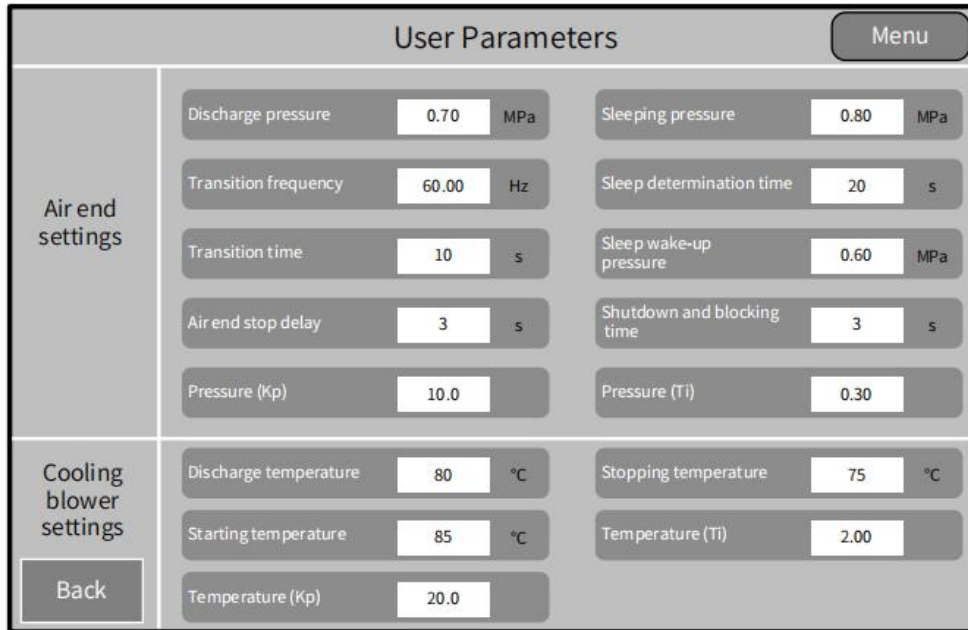

Figure 3-7 User parameter settings (example)

4) Touch "Maintenance Parameters" and "Protection Parameters" in sequence to set parameters related to the air compressor.

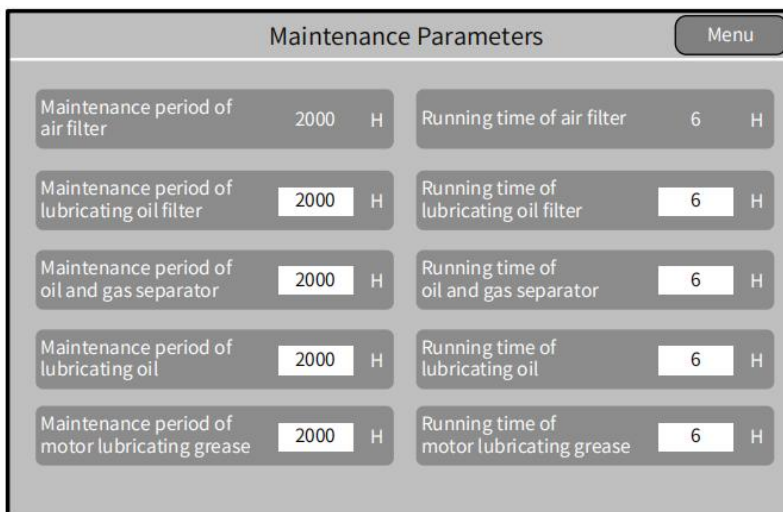

Figure 3-7 Maintenance parameter settings (example)

5) Touch "AC Drive Parameters" to set parameters

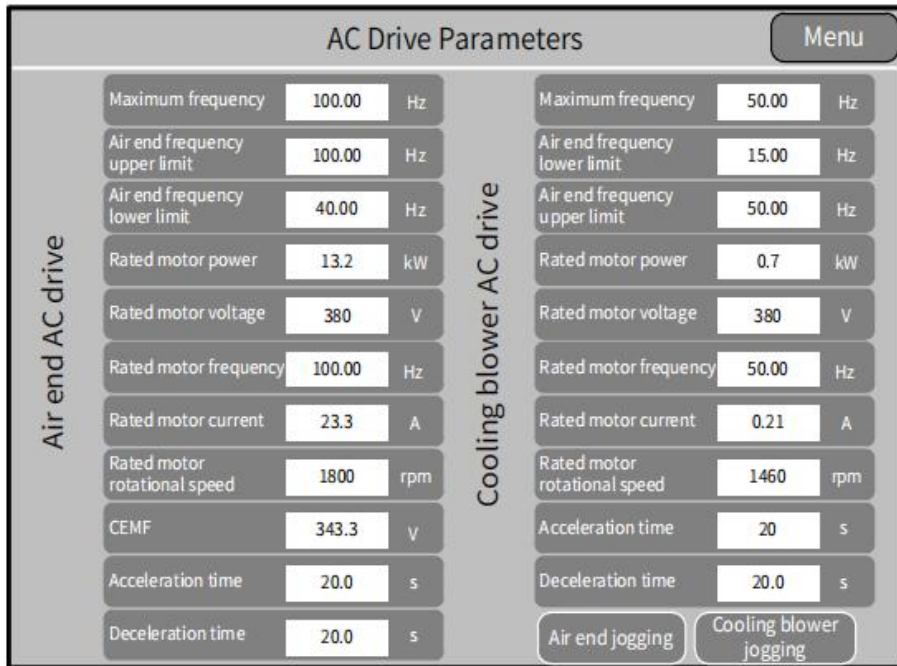

Figure 3-9 AC drive parameter settings (example)

6) Touch "Air End Jogging" and "Cooling Blower Jogging" respectively to conduct trial running. Observe the motor (including the compressor air end and mains frequency cooling blower) operation direction. If the motor operates in a wrong direction, disconnect the power supply and exchange the R and S phase sequences of the motor. Then, conduct trial running again until the motor operates in the correct direction.

7) Touch "Start" on the homepage shown in Figure 3-3 to start the air compressor check that the operating current and temperature are within the normal range, solenoid valve status is correct, and pressure and temperature changes are normal.

8) Shut down the air compressor. The commissioning is complete

2.4.2 Indicator light description

Power supply: The indicator light is on after the controller is powered on.

Running: When the air compressor motor is running, the running indicator light is on.

Fault: When fault occurs, the fault light is always on;

2.4.3 User parameter table and functions

A menu	Secondary menu	Set initial value	function
Pressure and temperature preset	Preset pressure	00.70MPa	The target force set during inverter control.
	Loading pressure	00.60MPa	1, Automatic loading mode, the controller automatically loads when the pressure is lower than this value In standby mode, the pressure is lower than this value, and the operating conditions are met, the controller automatically starts
	Unloading pressure	00.80MPa	1. If the pressure is higher than this value, the controller will automatically unload 2. This value should be less than or equal to "unloading high limit"
	Fan start temperature	0080 °C	When the exhaust temperature is higher than the value set here, the fan runs.
	Fan stop temperature	0070 °C	When the exhaust temperature is lower than the value set here, the fan stops.
Start-stop delay preset	Start delay	0010 s	Motor delay time
	Loading delay	0002 s	After corner operation, delay loading time (applicable to power frequency control)
	Unloading delay	0600 s	The longest continuous no-load operation time allowed by the air compressor exceeds Stop automatically after this time.
	Stop delay	0010 s	After the air compressor receives the stop command, it turns to no-load operation. After the load operation exceeds the time set here, it will automatically stop.
	Restart delay	0100 s	After a normal shutdown, an empty vehicle shutdown for a long time, or a fault shutdown, the air compressor can be restarted after delaying the time set here.
Maintenance parameter reset	Oil filter used	0000 hours	The accumulated used time of the oil filter. After replacing the new oil filter, Manually clear.
	Oil separator used	0000 hours	The accumulated used time of the oil separator. After replacing the new oil separator, Manually clear.
	Air filter used	0000 hours	The air filter has accumulated used time. After replacing the new air filter, Manually clear.
	Lubricant used	0000 hours	The accumulated used time of lubricating oil, after replacing lubricating oil, Manually clear.

	Grease used	0000 hours	The accumulated used time of the grease. After the grease is replaced, theManually clear.
Maximum use time preset	Oil filter preset	500 hours	1. When the accumulative use time of the oil filter exceeds the value set here, the controller will warn; 2. When set to "0000", the oil filter warning function is prohibited
	Oil separator preset	500 hours	1. When the accumulative use time of the oil separator exceeds the value set here, the controller will warn; 2. When set to "0000", the oil separator warning function is prohibited
	Air filter preset	500 hours	1. When the cumulative use time of the air filter exceeds the value set here, the controller will warn; 2. When set to "0000", the air filter warning function is prohibited
	Lubricant preset	500 hours	1.When the cumulative use time of lubricating oil exceeds the value set here, the controller will warn; 2. When set to "0000", the lubricating oil warning function is prohibited
	Grease preset	500 hours	1.When the accumulative use time of grease exceeds the value set here, the controller will warn; 2. When set to "0000", the lubricating oil warning function is prohibited
user password	****	****	Modifiable user password; can use old user password or factory Home password reset

2.4.4 Adjust parameters

The adjustment parameters are used to set the relevant data of the controller and are not allowed to be viewed and modified by users who are not authorized by the manufacturer. The user needs to verify the adjustment password before viewing the adjustment parameters.

Chapter 3 Installation and Acceptance

3.1 Installation, acceptance and storage:

The machine is transported from the factory to the site to be installed in place. The shutdown maintenance and correct maintenance are related to the integrity and normal use of the equipment. Therefore, after receiving the machine, you should immediately check whether there is any damage caused by transportation. If damage is found, the carrier can be asked to sign the shipping documents and make a damage report. If you did not find it in time at that time, but found concealed damage afterwards, please inform the carrier within 15 days after receiving the goods, and ask the carrier to make a damage report. A detailed report is very important for the handling of losses (claims).

Check the nameplate of the compressor to determine whether the machine is the model and specification you have ordered, and whether the options are included. At the same time, check the oil and gas barrel and safety valve to confirm whether the design or set pressure is correct. For the unit that is temporarily not installed or will not operate for a long time, a protection and maintenance plan must be set to ensure the normal operation of the unit, especially the main engine head.

3.2 Installation and positioning

This series of compressor units are used in indoor environments. The compressor should be placed in a clean and well-ventilated environment. The foundation should be firm. For safety and ease of maintenance and daily inspections, there must be enough space around the machine (in the vicinity of the compressor and Reserve at least 1.2 meters of space at the top, see Figure 3-2).

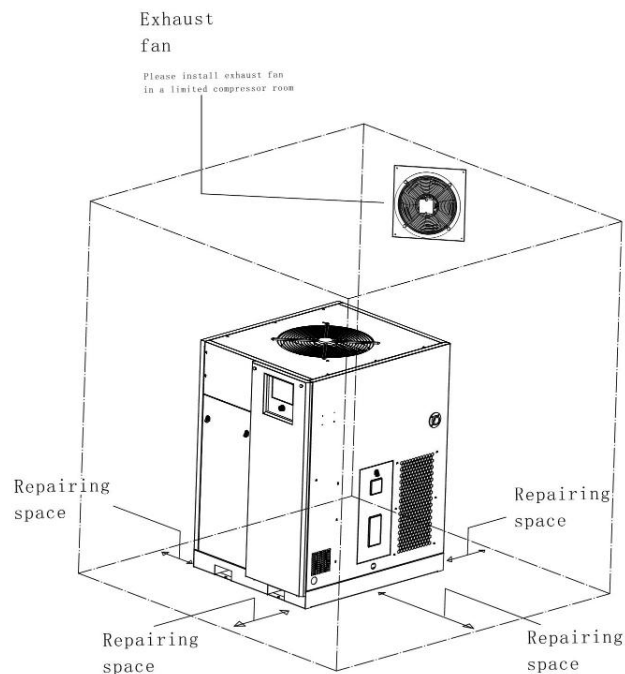
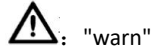
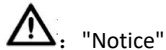

Figure 3-2 Installation space

The ambient temperature of the compressor should not exceed 40°C (104°F). Prevent the hot air discharged by the cooling fan from circulating in the machine room and causing the ambient temperature to rise. In principle, all the fixed screw compressors of Suzhou Chanun are for indoor installation. After modification, they can also be installed outdoors in some places. Rain, snow and freezing should be avoided.



The compressor cannot work in an environment below 0°C (32°F) or above the upper limit of the maximum operating temperature.



The compressor needs enough clean air for normal operation

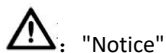

Removal or modification of the soundproof cover will generate high noise and endanger human health.

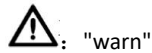

Do not install or expose the compressor to toxic, volatile, or corrosive gas, and do not store substances of similar nature near it, otherwise it will cause serious casualties and property losses.

For the design, installation and use of the compressor room, please refer to GBJ29-90 "Code for Design of Compressed Air Station".

3.3 Storage and maintenance of the whole machine

When the unit is placed for a long time or stops operating for a long time, you must first ensure that the installation environment is clean and dry. Check the main components and joints of the unit, clean to ensure that there is no leakage or rust, and run for at least 60 minutes every month to ensure the safe lubrication of the main unit head; secondly, check carefully before starting up, and replace the unit if necessary Lubricating oil, perform a 2-hour full-load operation test on the unit, record the data, and ask a qualified professional service engineer for guidance.

3.4 Installation, piping and electrical wiring

In any case, the pipe size should not be smaller than the connecting size of the compressor discharge pipe.

For the compressor, the air filter is indispensable, and the air source that can provide clean air should be selected.

3.5 Precautions for piping, foundation and cooling system

3.5.1 Precautions for air pipe piping

- 1) When piping the pipeline, the pipeline must have an inclination of 1-2 degrees to facilitate the drainage of condensed water in the pipeline.
- 2) The pressure drop of the piping should not exceed 5% of the set pressure of the air compressor, and it is better to choose a larger pipe diameter than the design value.
- 3) The branch pipeline must be connected from the top of the main pipeline to prevent the condensed water in the pipeline from flowing into the working machine or returning to the air compressor.
- 4) Do not reduce the main pipeline arbitrarily. If necessary, reduce or enlarge the pipeline, use a reducer. When the gas flows in the pipe, frictional resistance is generated in the straight pipe section: local resistance

is generated at the valve, tee, elbow, reducer, etc., which leads to gas pressure loss. The pressure drop within a length of pipeline can be checked from Table 3-1:

Table 3-1: Flow rate-piping pressure drop Kg/cm²-(100m)

Flow m ³ /min	Diameter (mm)					
	DN15	DN20	DN25	DN32	DN40	DN50
0.8	5.87	1.23	0.339	0.0858	0.038	
1.0	9.18	1.92	0.53	0.134	0.059	0.0157
1.6	23.5	4.9	1.36	0.343	0.152	0.0428
2.0		7.66	2.12	0.536	0.237	0.0668

instruction:

1. The actual pressure drop of straight pipe section = table value x pipe length/(100 x compression ratio).
(Compression ratio=gauge pressure+1)
2. Part of the pressure drop in the pipeline should also be added to the partial pressure loss produced by elbows, reducers, tee joints, valves, etc. These values can be checked from the relevant manuals.
3. For the selection of air compressor post-processing equipment (cold dryer, suction dryer, filter), see Table 3-2. Precision filter, C series centrifugal oil-water separator, T series main line filter, A series micro oil mist filter. H series of active adsorption filters are mainly used in food, medicine and pharmaceutical factories.
4. For compressed air with system pressure below 1.5MPa, the flow velocity in the delivery pipe must be below 15m/sec to avoid excessive pressure drop.
5. Minimize the use of elbows and various valves in the pipeline to reduce pressure loss.

3.5.2 Precautions for air compressor room ventilation

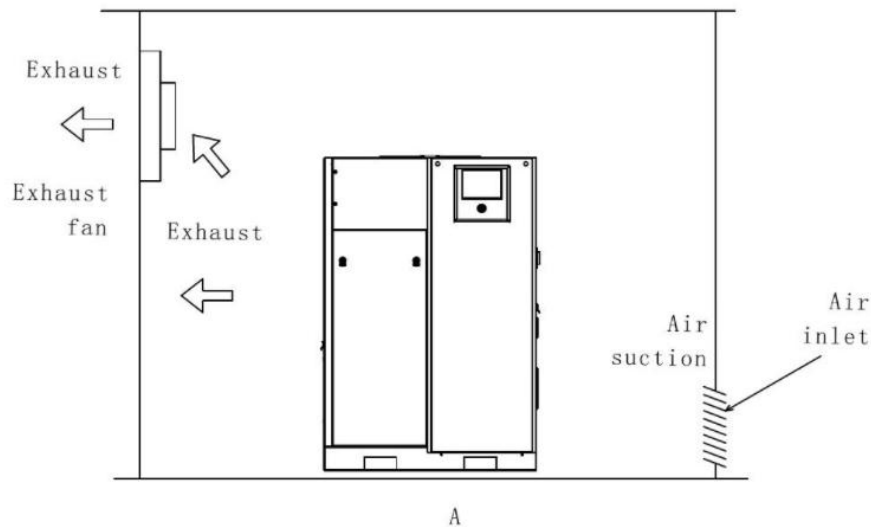

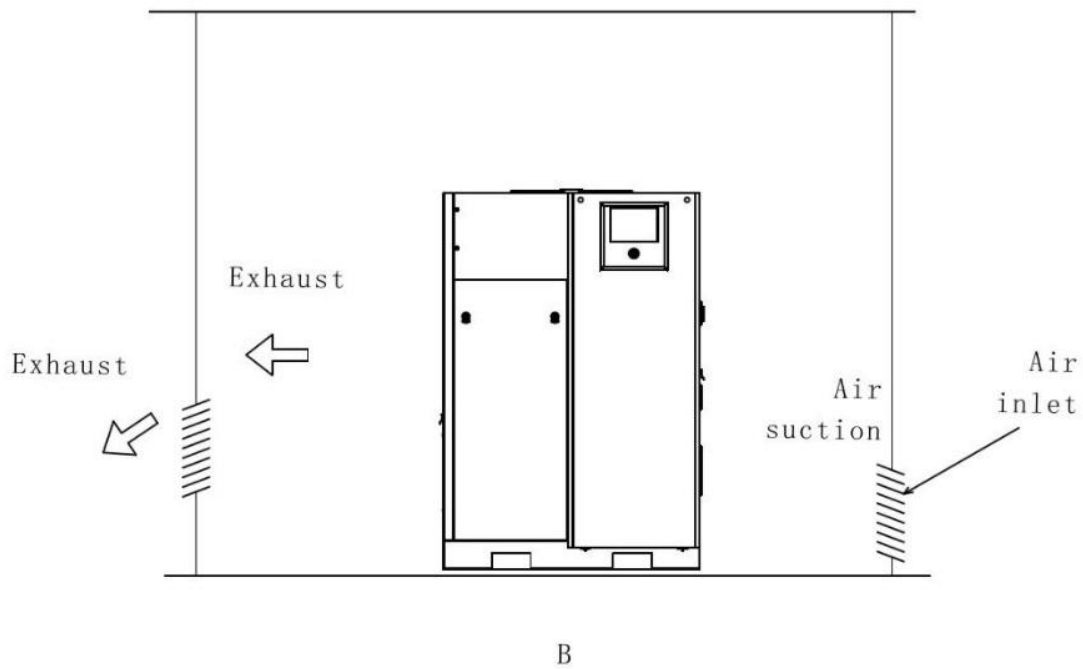

Figure 3-3 Indoor ventilation

When the compressor room is narrow, please install an exhaust fan higher than the side wall of the compressor exhaust port, and set the air intake port at a low place on the intake side wall (see Figure 3-3 A). When the compressor is installed in a spacious workshop, please choose a well-ventilated location for installation (see Figure 3-3 B).

3.6 Installation of safety facilities

3.6.1 Safety valve (pressure relief valve)

The safety valve is a pressure relief device used to protect the system. It has been set at the factory. You cannot change its pressure setting or block this valve at will. Only safety valve manufacturers or qualified agents can carry out this work. The gas discharged from the safety valve should be led to a safe place away from the crowd.

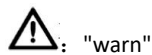

It is not allowed to change, weld, repair or reprocess GB (or ASME) pressure vessels, and it is not allowed to use them under conditions exceeding the rating of the nameplate, otherwise it will affect the insurance clauses and cause serious personal injuries and property losses.

3.6.2 Protective cover

All mechanical movements have different degrees of danger, so a protective cover should be provided. This series of units is fully equipped with necessary protective facilities in accordance with national and industry standards. Users should check and maintain them regularly, and cannot be changed or dismantled at will.

3.6.3 Manual vent valve and shut-off valve

It is recommended to install a manual vent valve in the customer's air system. The purpose of installing the

manual vent valve is to discharge the air in the compressor and its exhaust pipe to the atmosphere. When the system gas tank is only used with a single compressor, the vent valve can be installed on the gas tank. If a shut-off valve is installed in the system, the manual vent valve should be installed upstream of the shut-off valve. This configuration ensures maintenance and Personnel and equipment are in a safe state during maintenance.

If it is only to isolate the compressor from the system for maintenance, please be careful not to replace the stop valve with a check valve.

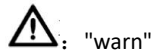

The manual vent valve must be opened before servicing the machine to vent the pressure in the compressor and the system. Negligence in reducing the pressure of the system may cause serious personal injury, death and property damage.

3.7 Electrical installation

Before installation, check whether the power supply, power cord, and transformer capacity are consistent. Appropriate fuses or circuit breakers should be equipped during installation. The unbalance between voltage phases must be limited to less than 5% to prevent overcurrent caused by low voltage. User power cord and air switch selection, see Table 3-3 for details, user air switch current specifications are selected at 1.5-2 times the total current. The compressor must be well grounded, see electrical wiring diagram.

Table 3-3: User power cord and air switch selection

Voltage (V)	Rated power (kW)	Line current (A)	Calculation of current-carrying capacity of customer power cord diameter at 40°C	User air switch specifications are not less than the following current (A)
380	11	20	3*4mm ² +2.5mm ²	40
380	15	28	3*6mm ² +4mm ²	63
380	18.5	35	3*10mm ² +6mm ²	80
380	22	43	3*10mm ² +6mm ²	80
380	30	58	3*16mm ² +10mm ²	125
380	37	65	3*16mm ² +10mm ²	125
380	45	80	3*25mm ² +16mm ²	160
380	55	97	3*35mm ² +25mm ²	200
380	75	124	3*50mm ² +35mm ²	250

Note:

2. If the power distribution cabinet is far away from the air compressor, the wire diameter needs to be increased accordingly to prevent excessive voltage drop from affecting the operation of the machine.

Power inlet wiring

3.8 Wiring diagram (open the inverter cover):

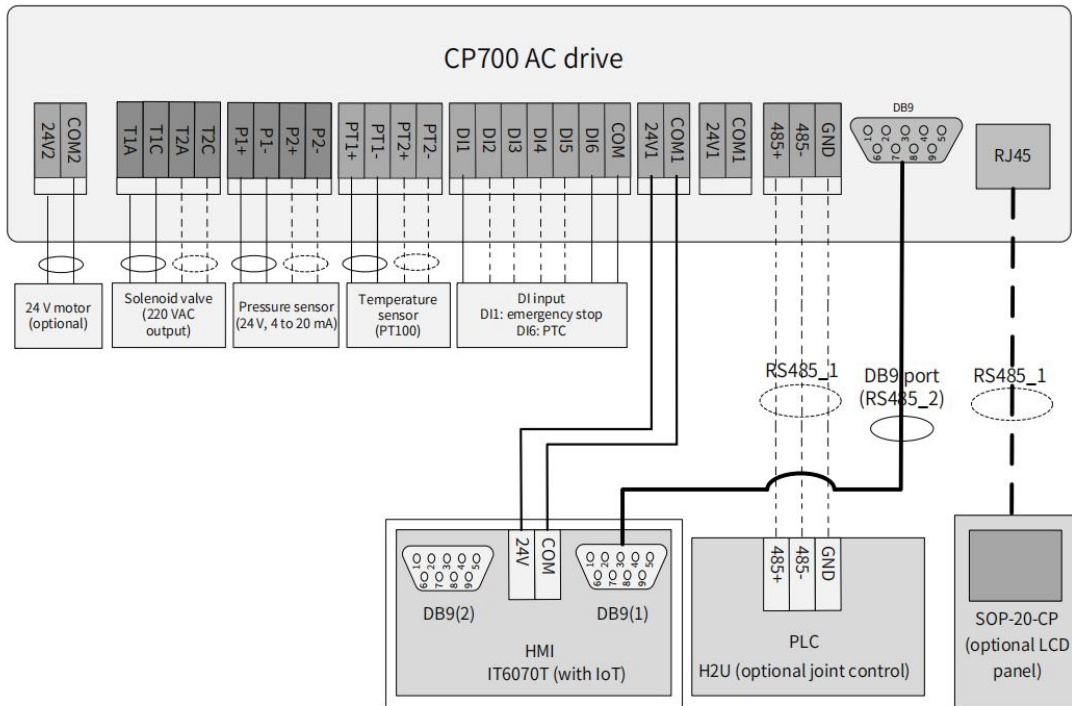

Chapter 4 Operating Rules

4.1 Overview

This series of screw compressor units are equipped with a series of control elements and display/indicating elements. In order to ensure the normal operation of the unit, the operator needs to be able to operate the machine correctly, and it is also required that the operator can make correct judgments on the operating status or fault conditions of the unit based on the displayed/indicated values or conditions. Before starting the unit, the operator should be familiar with the position, function and usage of the control/control elements and display/indication elements. Refer to the controller manual for details.

4.2 Ready to start

- 1) Remove the debris and tools around the compressor.
- 2) Remove the bolts or devices for transportation and fixation.
- 3) Check the oil level to make sure it is in the normal position (see Lubricants section).
- 4) Check the fan to make sure it is installed firmly.
- 5) Check whether all pressure pipe joints are firm and not loose.
- 6) Open the air supply valve.
- 7) Check and make sure that the safety valve is installed in place.
- 8) Check whether all cover plates and protective devices are safe and firm.
- 9) Check whether the current setting of the fuse, circuit breaker or controller is suitable and whether the setting is correct.
- 10) Check whether the air filter is installed reliably.
- 11) Turn on the power switch, the screen light is on. Jog the start button to ensure that the compressor steering is consistent with the prescribed steering.
- 12) Please turn on the switch of the cooling and drying machine (C5F)

4.3 Routine start-up steps

- 1) Open the shut-off valve leading to the air supply system.
- 2) Press the start button after presetting the control parameters.
- 3) Observe whether the compressor has abnormal vibration, noise, or gas/oil leakage after starting. If any problem is found, please stop it immediately and make corrections.
- 4) Close all the soundproof cover doors to control the noise of the unit and ensure the normal flow of cooling air.
- 5) Slowly close the air supply shut-off valve and check whether the unit is unloaded according to the setting. Refer to Chapter 6 Working Condition Parameter Setting and Adjustment.
- 6) Check whether the indicated value of each status parameter is normal.
- 7) Please carefully observe the operation of the compressor during the first hour of operation, and observe it at any time for the next seven hours. If there is any abnormality, please shut down for maintenance.
- 8) After the initial operation, shut down according to the shutdown procedure, and check whether the oil tank

needs to be filled with lubricating oil; check whether the connections are loose.  "Notice":

① Drain the condensed water at the bottom of the oil and gas barrel regularly. The operation of discharging condensate should be carried out before starting the unit.

② Drain the condensate at the bottom of the control line filter regularly (weekly). The operation of discharging condensate should be carried out before starting the unit

4.4 Shutdown procedure

4.4.1 Press the stop button.

4.4.2 Close the shut-off valve leading to the air supply system.

4.4.3 Turn off the power switch.



"Caution": Closing the shut-off valve during shutdown can prevent the compressed air of the air supply system from flowing back to the compressor due to the damage of the check valve, causing leakage and damage to the mechanical parts.

1. Emergency stop: In abnormal conditions, press the emergency stop/reset switch to stop, and cut off the power switch.

Chapter 5 Maintenance

5.1 Preparation before maintenance

In order to ensure the normal operation and long service life of the unit, good maintenance is the key. Therefore, the maintenance procedures for screw compressor units must be carefully implemented. Before proceeding with maintenance, please read carefully the safety rules in Chapter 1 of this manual, and make at least the following preparations:

- 1) Cut off the power of the host and hang a sign on the power switch.
- 2) Close the shut-off valve leading to the air supply system to prevent the compressed air from flowing back to the repaired part.
- 3) Open the manual vent valve to vent the pressure in the system and keep the vent valve in an open state.
- 4) Ensure that the compressor unit is cooled to prevent scalds and burns.
- 5) Wipe off oil and water marks on the ground to prevent slippage.



"warn"

- Don't think that the machine is shut down, just think that it can be overhauled and maintenance work, the automatic control system of the machine will start the compressor at any time.
- Poor maintenance not only affects the normal operation of the unit, but may also affect the safety of operators.
- When the compressor is running or under pressure, do not disassemble nuts, filler plugs and other parts.
- Do not use flammable solvents such as gasoline or kerosene to clean the air filter or other parts. Safe solvents should be used according to the instructions.

5.2 Maintenance of screw compressor



"Attention": Only trained and qualified maintenance personnel are qualified to perform maintenance on the machine.

5.2.1 Replacement of air filter

element:

1. Unscrew the dovetail screw on the top of the air filter housing



1. Unscrew the dovetail screw on the top of the air filter housing



5.2.2 Cooling oil

replacement:

1. Prepare the container, remove the oil drain plug and release the old cooling oil

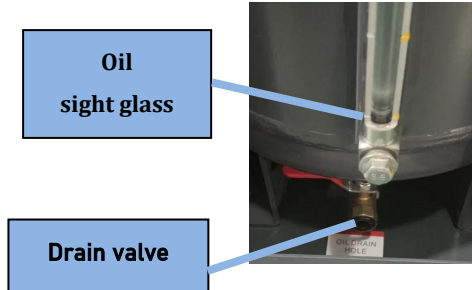

2. Open the refueling plug and add special cooling oil, Recover the plug after reaching the 2/3 to 3/4 position of the oil sight glass

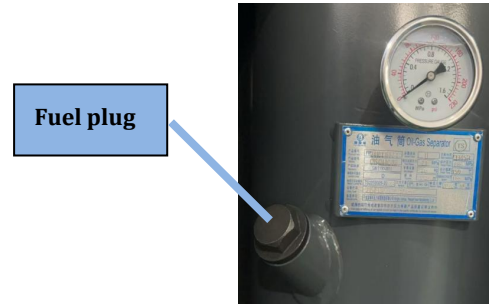

5.2.3 Replacement of oil filter and oil-air

separator:

1. Use a belt wrench or special wrench to remove the old product
2. Clean the installation surface, apply a thin layer of cooling oil of the same product name to the new product seal ring, pee-tighten it by hand, and then tighten it with a wrench

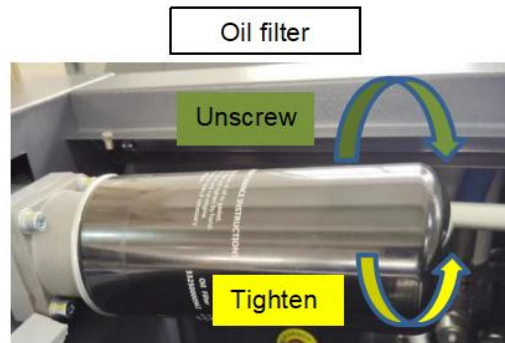
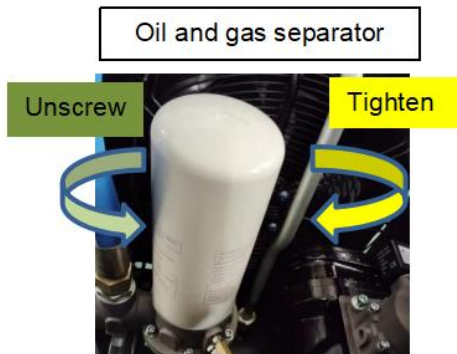

5.3 Maintenance tips and update setting method after maintenance:

Modify the "used time" on the control panel, it can be cleared after this maintenance, and the system will automatically restart timing.

5.5 Maintenance plan

Period(number of hours)	Recommended actions	Spare parts set
100 (Or weekly)	Check the oil level Clean the air filter Clean the radiator (exterior) Gas storage tank blow down Cleaning and dust removal inside the screw machine	maintainance
500 First guarantee	Replace the special lubricating oil for screw machine Replace the oil filter Replace the oil fine separator Replace the air filter element Check the control switch cable screw Check the seal (each joint, air pipe) Clean the radiator (exterior) Gas storage tank blow down Cleaning and dust removal inside the screw machine	Consult the manufacturer for spare parts
Every3000	Replace the special lubricating oil for screw machine Replace the oil filter Replace the oil fine separator Replace the air filter element Check the control switch cable screw Check the seal (each joint, air pipe) Clean the radiator (exterior) Gas storage tank blow down Cleaning and dust removal inside the screw machine	Consult the manufacturer for spare parts
5000	(In addition to maintenance items every 2000 hours) Replace the main engine shaft seal clean oil and gas separator oil Clean the oil return check valve (Replace if necessary) Clean the intake valve (Replace if necessary) Clean the intake valve (Replace if necessary) control (Finally changed) Motor bearing Clean the radiator (Inside and outside)	Consult the manufacturer for spare parts
20000	(In addition to maintenance items every 8000 hours) Replace the main engine bearing	Consult the manufacturer for spare parts

This maintenance plan is based on all installation and operating parameters recommended by the manufacturer. The manufacturer recommends setting up a compressor maintenance work log for later maintenance.

The operating hours shown in the table refer to the best use of the machine, and may vary depending on the workplace and the number of cycles.

5.6 Common troubleshooting table (Power and gas must be cut off during manual inspection)

problem	reason	solution
Too high oil temperature causes shutdown	The exhaust temperature of the body is too high (maximum 105°C)	<ul style="list-style-type: none"> - Check the oil level; - Check the cleanliness of the cooler - Check if the fan is working properly - Check whether the temperature sensor is working properly <p>The reset button must be pressed before restarting the machine. If high temperature occurs repeatedly, please contact the service center</p>
Motor overheated causing shutdown	<ul style="list-style-type: none"> - The voltage is too low. - Motor temperature is too high - Power consumption is too high 	<ul style="list-style-type: none"> - If the machine is turned on when a fault occurs, check whether the phase sequence is stable; - If the fault occurs, the machine is running, confirm the internal pressure and replace the oil separator - If the current of the motor is higher than the rated current, please contact the technical staff of the service center. - Don't force start, so as not to cause more damage to the compressor control board. - Check whether the voltage and frequency match
Safety valve open	<ul style="list-style-type: none"> - Pressure sensor failure - The set pressure exceeds the set value of the safety valve - Oil fine separator blocked 	<ul style="list-style-type: none"> - Check whether the pressure sensor and barometer parameters are normal - Check whether the setting value of the control panel matches the safety valve parameter - Replace the safety valve - Remove and replace the oil fine separator
The compressor is running but the pressure is too low	<ul style="list-style-type: none"> - The intake valve is not open. - Pressure cannot be increased due to leakage - Transmission element blocking 	<ul style="list-style-type: none"> - When the air compressor is stopped and the internal pressure is safe, remove the air filter and check whether the valve can move - Check the pipeline for leaks - Check carefully whether the motor is running but the body is not running. - Contact the service center
Air filter injection	<ul style="list-style-type: none"> - Oil level is too high - The oil-returning sight glass is dirty - Oil fine separator failure 	<ul style="list-style-type: none"> - Drain the excess oil during shutdown and check the oil level. - Remove the oil return sight glass and clean it, and replace it if necessary.

	<ul style="list-style-type: none"> - The intake valve bleeds too fast 	<ul style="list-style-type: none"> - Replace the oil fine separator and clean the core tube.
<p>Main motor overload</p>	<ul style="list-style-type: none"> - Low voltage - Power phase loss - High pressure in oil and gas barrels 	<ul style="list-style-type: none"> - Confirm input power - Check whether the three-phase input of the power supply is close to the value and whether it is reliably connected to the terminal - Check the cable for damage - Check whether the ventilation of the main motor is unobstructed. - If the motor has only two-phase input, it should be checked by a qualified technician. (If necessary, replace or repair the motor) - If the pressure difference of the oil and gas barrel is greater than 1 bar, it will cause high energy consumption of the system. Check the system by a qualified technician. - The ambient temperature is too high: ventilation - Restart the machine and press the reset switch on the control panel
<p>Excessive fuel consumption</p>	<ul style="list-style-type: none"> - The faulty oil of the oil fine separator is not suitable for the compressor. - Worn or defective air/oil separator element. - Oil level is too high. 	<ul style="list-style-type: none"> - Change the oil and fill the machine with the oil specified by the manufacturer. - Replace the oil fine separator. - Clean or replace the oil return sight glass. - Replenish oil until the oil level reaches the correct position specified in the manual

5.7 Schematic diagram of screw fitting explosion

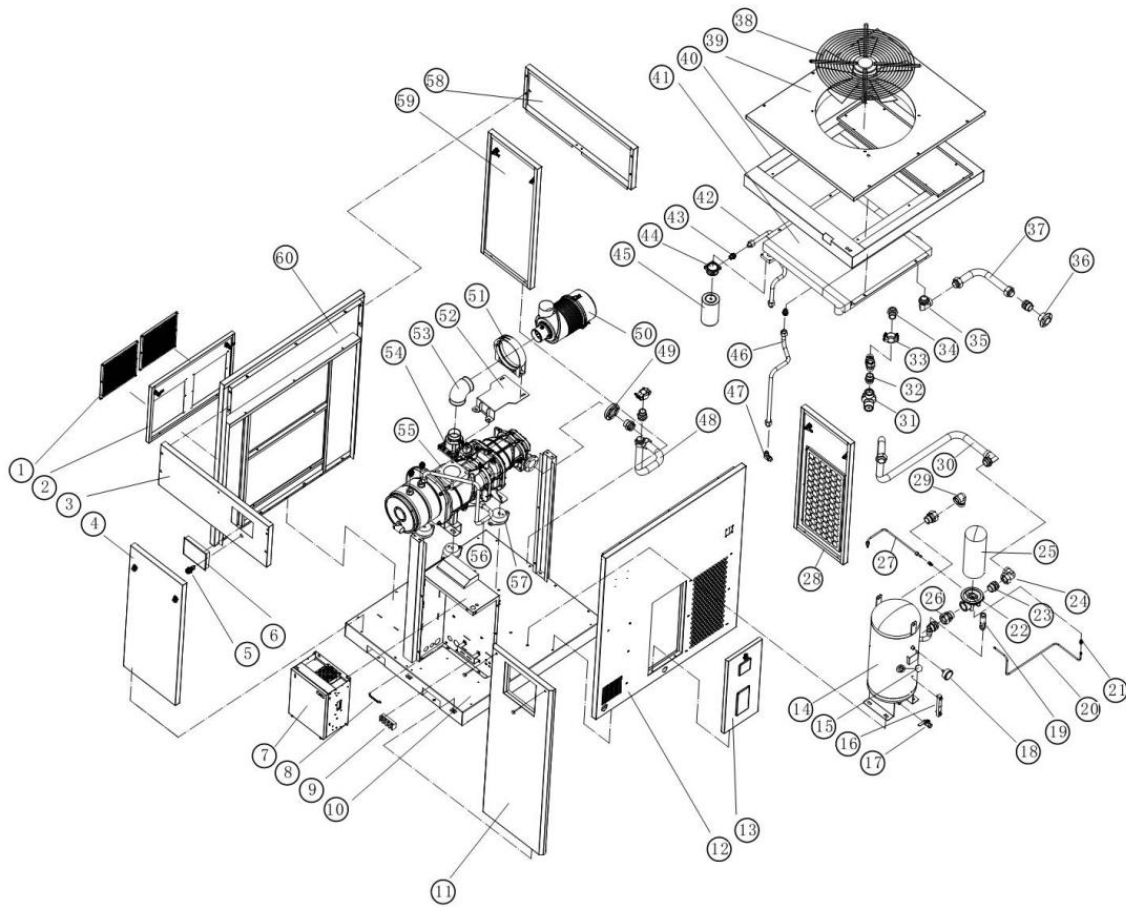

NO	Part Name	quantity	NO	Part Name	quantity	NO	Part Name	quantity
1	Filter	2	26	Direct head G1-1/2-M52X2 (nut)	1	51	Air filter hoop	1
2	Left movable door panel	1	27	Secondary oil return pipe	1	52	Air filter bracket	1
3	Front upper fixed door panel	1	28	Rear lower right door panel	1	53	Air filter elbow	1
4	Front Lower Left Door Panel	1	29	Elbow M52X2-DN32	1	54	Air inlet valve	1
5	Emergency stop	1	30	Cooler inlet pipe	1	55	Screw host assembly	1
6	Control Panel	1	31	Minimum pressure valve	1	56	Oil cooler motor outlet	1
7	Inverter	1	32	Fitting G1-1/4-M45X2	1	57	Shock absorber pad	4
8	Ground terminal	1	33	Hoop DN32	2	58	Rear upper door panel	1
9	Ground Terminal	1	34	Direct header M52X2-DN32	2	59	Rear lower left door panel	1
10	Chassis	1	35	Elbow G1-1/2-M52X2	1	60	Left door panel	1
11	Front Right Door Panel	1	36	Exhaust flange G1-1/2	1	61		
12	Right Door Panel	1	37	Cooler outlet pipe	1	62		
13	Right movable door panel	1	38	Blower	1	63		
14	Oil Tank	1	39	Top cover	1	64		
15	Fuel filler plug	1	40	Air guide cover	1	65		
16	Oil mirror	1	41	Cooler	1	66		
17	Drain valve	1	42	Cooler outlet pipe	1	67		
18	Pressure gauge	1	43	Direct head G3/4-M30X2	5	68		
19	Safety Valve	1	44	Oil filter holder	1	69		
20	Unloading pipe	1	45	Oil filter	1	70		
21	Direct head G1/4-M14X1.5	1	46	Cooler oil inlet pipe	1	71		
22	Oil separator	1	47	Elbow G3/4-M30X2	1	72		
23	Direct head G1-1/2-M52X2	1	48	Main oil pipe	1	73		
24	Elbow M52X2 (nut)	1	49	Main unit flange G1-1/2	1	74		
25	Oil parting	1	50	Air filter assembly	1	75		



苏州晨恩斯可络压缩机有限公司

CHANUN Suzhou Chanun Compressor Co., Ltd.

地址：苏州工业园东富路 58 号

Address: No. 58, Dongfu Road, Suzhou Industrial Park

邮编：215123

Zip code: 215123

服务热线：4006919399

Service Hotline: 4006919399

总机：0512-62529535

Switchboard: 0512-62529535

传真：0512-62870765

Fax: 0512-62870765

网址：www.chanun.com.cn

Website: www.chanun.com.cn

E-Mail: sales@chanun.com.cn